

## KLOVER WEATHER GUARD STANDARD CURTAIN WALL STUD DETAILS

Sheet Number	Sheet Name
KWG-C-ST-01	MULTI-STORY VERTICAL PANELS STACKED
KWG-C-ST-02	MULTI-STORY VERTICAL PANELS STACKED 2 HR.
KWG-C-ST-03	SPANDREL PANEL W/SUPPORT BRACE AT WINDOW HEAD
KWG-C-ST-04	SPANDREL PANEL W/SUPPORT BRACE AT WINDOW HEAD 2 HR.
KWG-C-ST-05	SPANDREL PANEL WITH FIXED CLIP FLOOR SUPPORT
KWG-C-ST-06	SPANDREL PANEL WITH FIXED CLIP FLOOR SUPPORT 2 HR.
KWG-C-ST-07	SPANDREL PANEL WITH INFILL WINDOWS
KWG-C-ST-08	SPANDREL PANEL WITH INFILL WINDOWS 2 HR.
KWG-C-ST-09	PARAPET WITH FOUNDATION SUPPORTED WALL PANEL
KWG-C-ST-10	PARAPET WITH FOUNDATION SUPPORTED WALL PANEL 2 HR.



### INDEX SHEET LIST

1121 RICHLAND COMMERCE DRIVE; SUITE B  
QUAKERTOWN, PA 18951

Scale

Date:

06/29/21

**KWG-C-INDEX-01**

## KLOVER WEATHER GUARD STANDARD CURTAIN WALL FRAMED OPENING DETAILS

Sheet Number	Sheet Name
KWG-C-FO-01	WINDOW HEADER & SILL DETAIL
KWG-C-FO-02	WINDOW HEADER & SILL DETAIL 2 HR.
KWG-C-FO-03	WINDOW JAMB
KWG-C-FO-04	WINDOW JAMB 2 HR.
KWG-C-FO-05	DOOR HEADER
KWG-C-FO-06	DOOR HEADER ALTERNATE
KWG-C-FO-07	DOOR HEADER 2 HR.
KWG-C-FO-08	DOOR HEADER 2 HR. ALTERNATE
KWG-C-FO-09	DOOR JAMB
KWG-C-FO-10	DOOR JAMB ALTERNATE
KWG-C-FO-11	DOOR JAMB 2 HR.
KWG-C-FO-12	DOOR JAMB 2 HR. ALTERNATE
KWG-C-FO-13	DOOR HEADER WITH BLOCKING 2 HR. ALTERNATE
KWG-C-FO-14	WINDOW BOXED HEAD & SILL WITH BLOCKING
KWG-C-FO-15	WINDOW BOXED HEAD & SILL WITH BLOCKING 2 HR.
KWG-C-FO-16	WINDOW & CURTAIN WALL JAMB WITH BLOCKING
KWG-C-FO-17	WINDOW & CURTAIN WALL JAMB WITH BLOCKING 2 HR.

## KLOVER WEATHER GUARD STANDARD CURTAIN WALL PANEL JOINT DETAILS

Sheet Number	Sheet Name
KWG-C-PJ-01	PANEL JOINTS- EXTERIOR
KWG-C-PJ-02	PANEL JOINTS - EXTERIOR 2 HR.
KWG-C-PJ-03	PANEL JOINT - VAPOR BARRIER FIELD TAPING OVER SHEATHING
KWG-C-PJ-04	PNL JNT - VAPOR BARRIER FIELD TAPING OVER SHEATHING 2 HR.



## INDEX SHEET LIST

1121 RICHLAND COMMERCE DRIVE; SUITE B  
QUAKERTOWN, PA 18951

Scale

Date:

06/29/21

**KWG-C-INDEX-02**

**DISCLAIMER**

**THESE DETAILS ARE BASED ON INDUSTRY ACCEPTED PRACTICES AND PROVIDE GENERAL GUIDELINES FOR PREFABRICATED COLD FORMED METAL FRAMING (CFMF) ASSEMBLIES, APPLICATIONS, INSTALLATION AND ASSOCIATED COMPONENTS. THESE DETAILS ARE PROVIDED FOR GENERAL INFORMATIONAL PURPOSES ONLY AND ARE NOT PROJECT SPECIFIC.**

**MANY DETAILS CONTAIN ITEMS MARKED "BY OTHERS" WHICH MEANS THEY ARE NOT SUPPLIED BY KLOVER (UNLESS SPECIFICALLY IDENTIFIED AND AGREED TO BY CONTRACT). THE PURPOSE IN INCLUDING THESE ITEMS IS TO SHOW GENERAL DESIGN CONCEPTS BETWEEN THE VARIOUS COMPONENTS TYPICALLY SUPPLIED BY DIFFERENT VENDORS AS PART OF WALL, FLOOR OR ROOF ASSEMBLIES AND JUNCTURES.**

**IT IS THE RESPONSIBILITY OF THE ARCHITECT TO PROVIDE THE PROPER DESIGN INTENT. ALL COMPONENTS SHOWN MUST BE DESIGNED AND INSTALLED PER THE LICENSED ENGINEER OF RECORD AND SPECIALTY STRUCTURAL ENGINEER FOR EVERY PROJECT.**



**INDEX SHEET DISCLAIMER**

1121 RICHLAND COMMERCE DRIVE; SUITE B  
QUAKERTOWN, PA 18951

Scale

Date:

06/29/21

**KWG-C-INDEX-03**

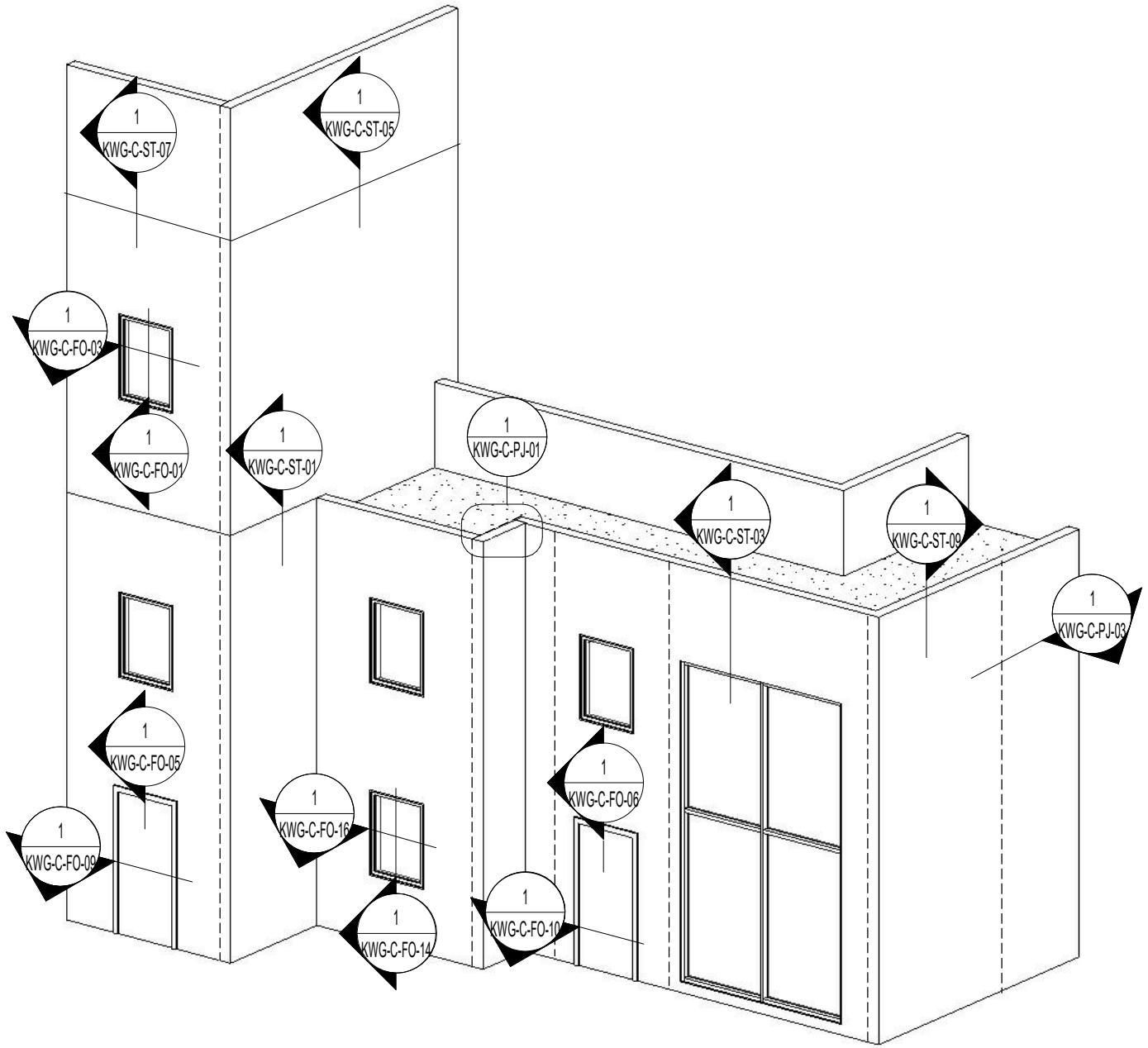

**KLOVER**

ISOMETRIC DETAIL - EXTERIOR  
TYP. CONDITIONS

1121 RICHLAND COMMERCE DRIVE; SUITE B  
QUAKERTOWN, PA 18951

Scale 3/16" = 1'-0"

Date: 06/29/21

**KWG-C-INDEX-04**

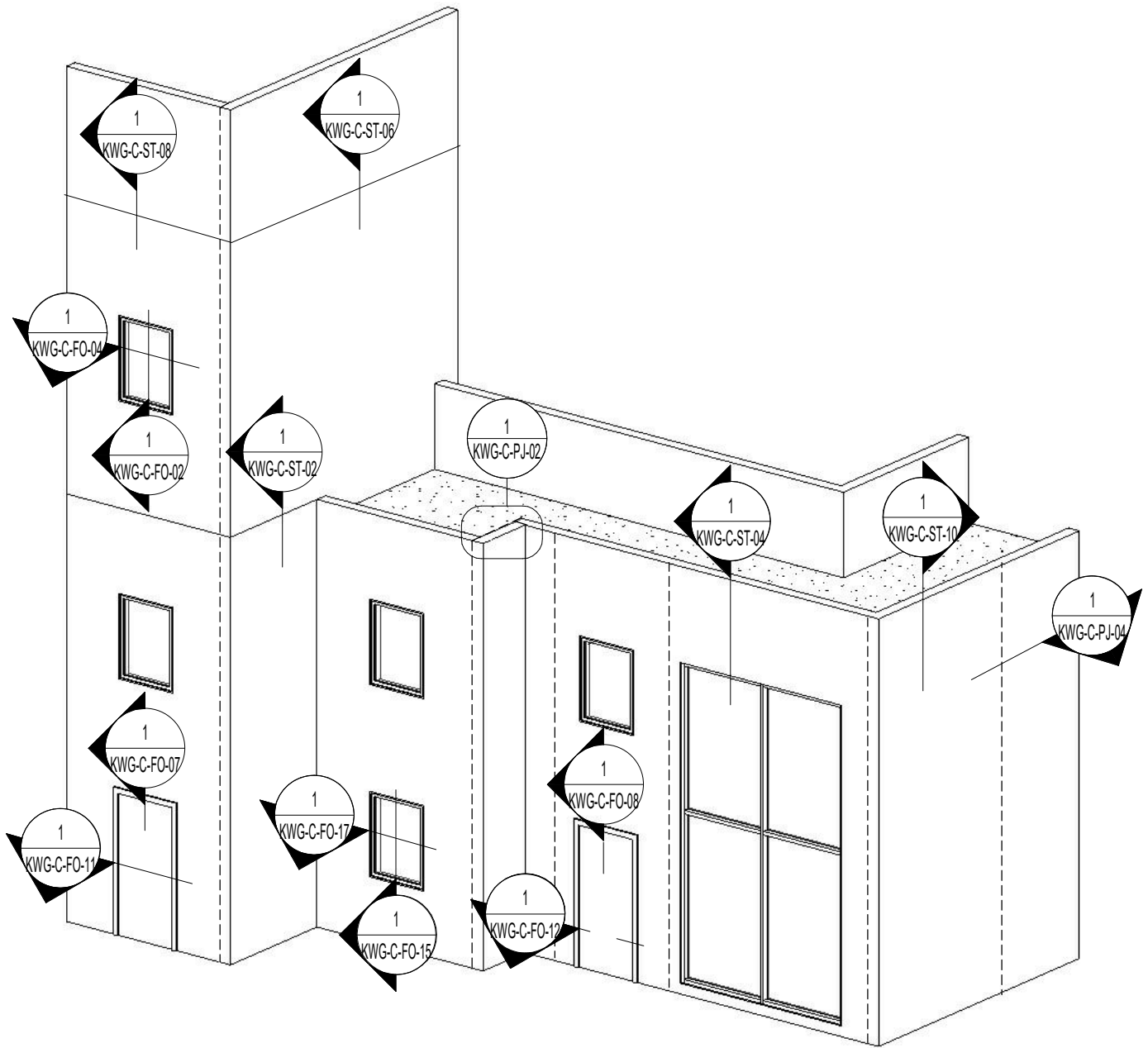

**KLOVER**

**ISOMETRIC DETAIL - EXTERIOR  
CONDITIONS - 2HR.**

1121 RICHLAND COMMERCE DRIVE; SUITE B  
QUAKERTOWN, PA 18951

Scale 3/16" = 1'-0"

Date: 06/29/21

**KWG-C-INDEX-05**

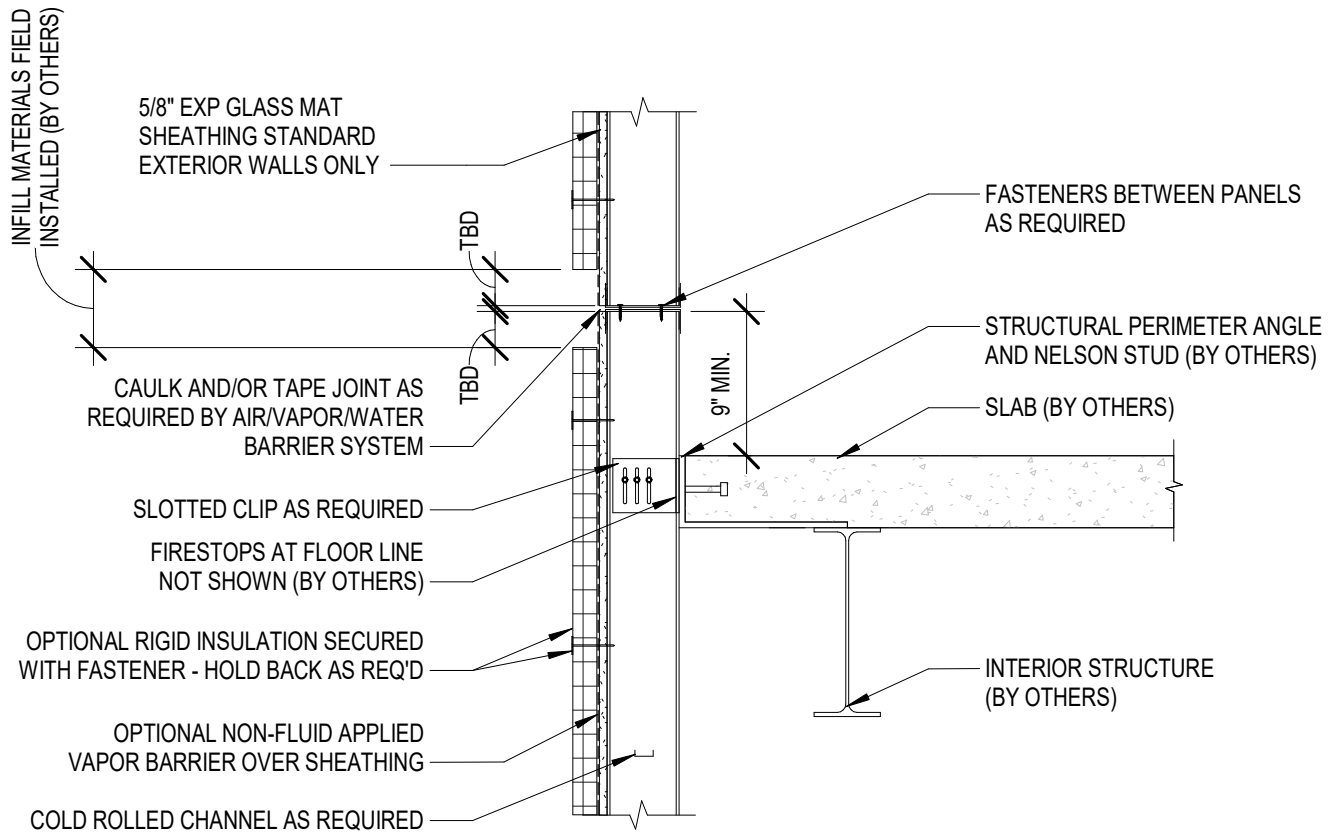

REFERENCE DETAIL ONLY - CONSULT WITH CFMS STRUCTURAL ENGINEER FOR SIZING, BRACING AND ATTACHMENT REQUIREMENTS



# MULTI-STORY VERTICAL PANELS STACKED

1121 RICHLAND COMMERCE DRIVE; SUITE B  
QUAKERTOWN, PA 18951

Scale 3/4" = 1'-0"

Date: 06/29/21

KWG-C-ST-01

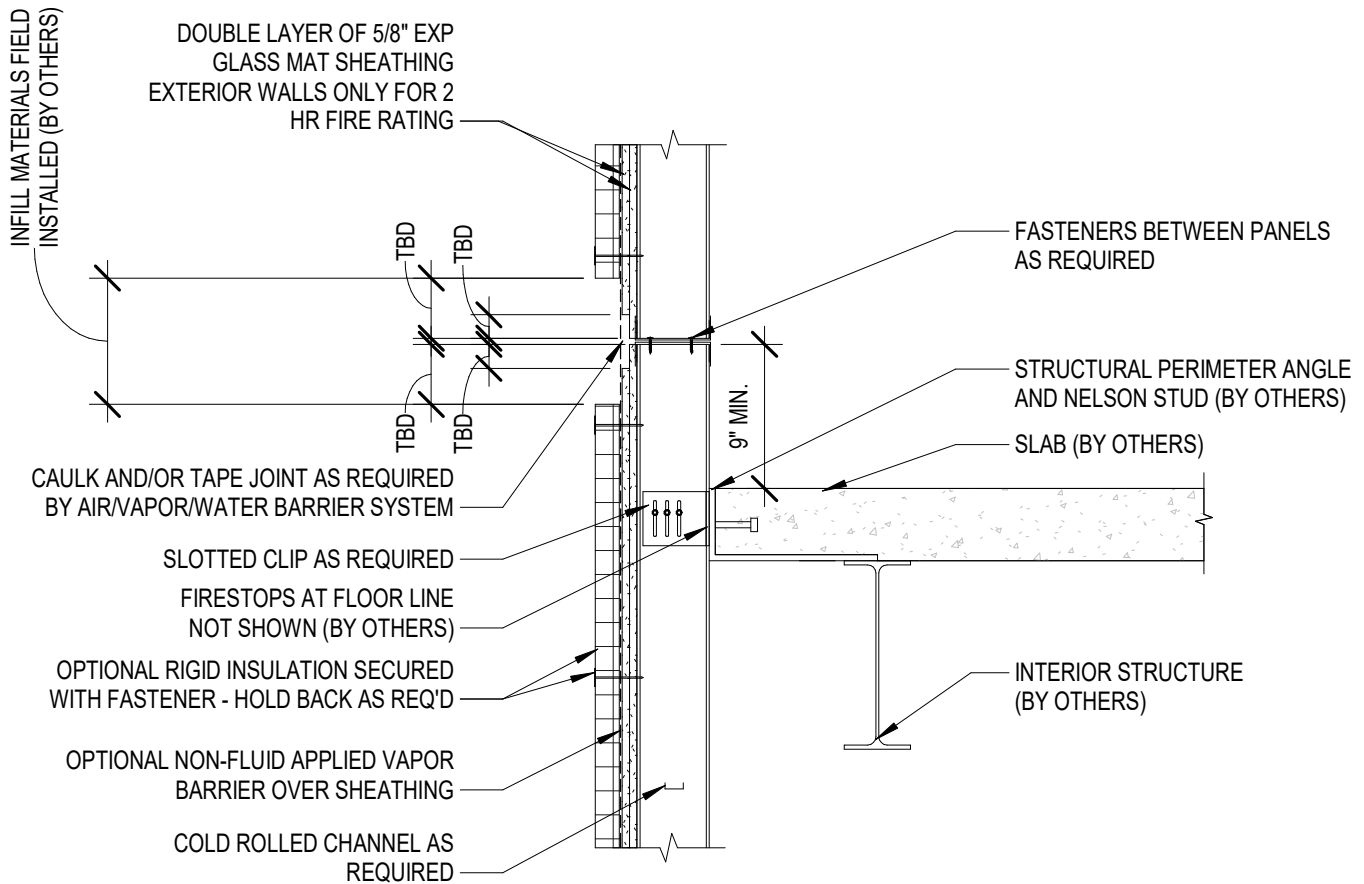

REFERENCE DETAIL ONLY - CONSULT WITH CFMS STRUCTURAL ENGINEER FOR SIZING, BRACING AND ATTACHMENT REQUIREMENTS



**MULTI-STORY VERTICAL PANELS STACKED 2 HR.**

1121 RICHLAND COMMERCE DRIVE; SUITE B  
QUAKERTOWN, PA 18951

Scale 3/4" = 1'-0"

Date: 06/29/21

**KWG-C-ST-02**

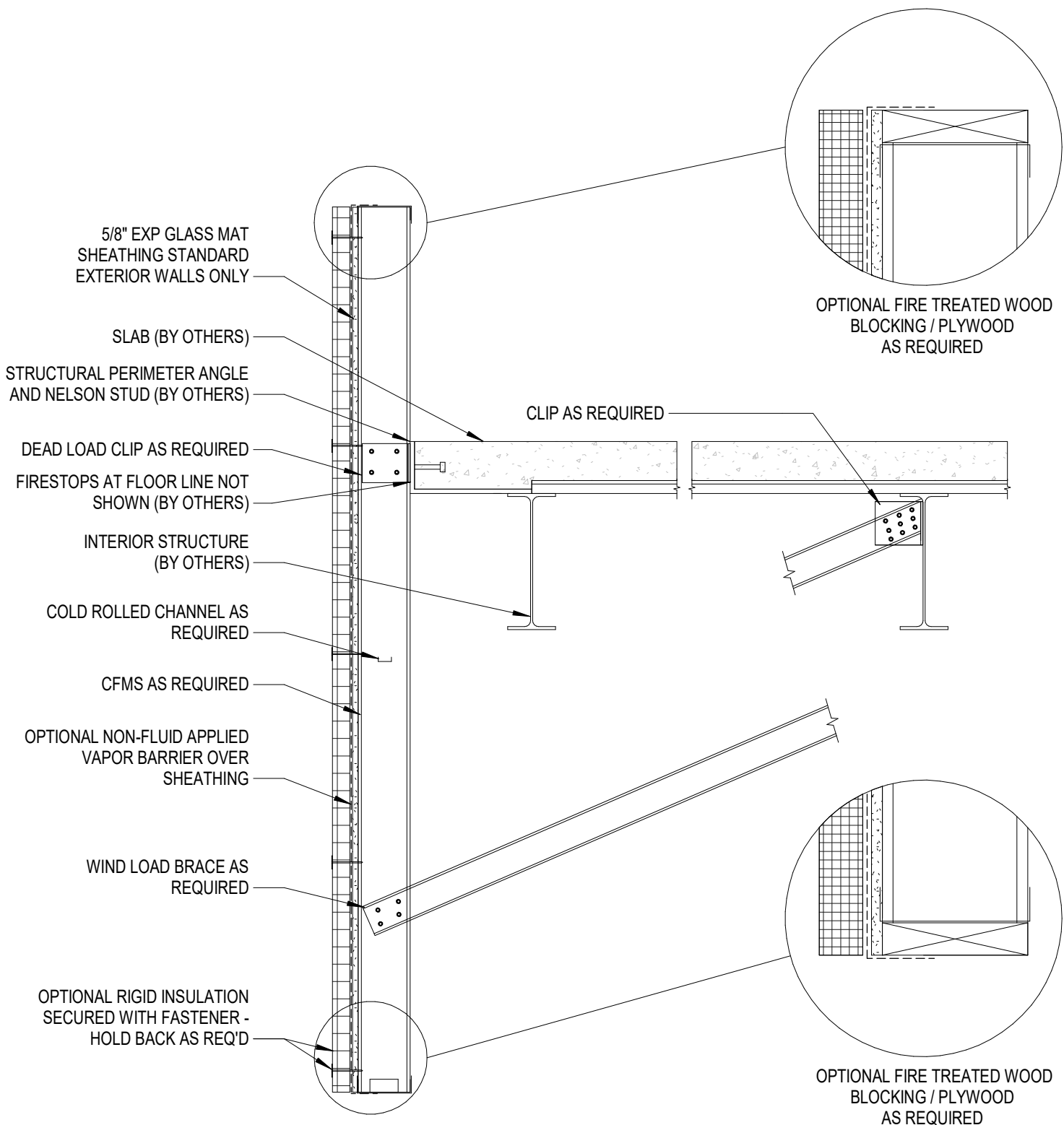

REFERENCE DETAIL ONLY - CONSULT WITH CFMS STRUCTURAL ENGINEER FOR SIZING, BRACING AND ATTACHMENT REQUIREMENTS



**SPANDREL PANEL W/SUPPORT BRACE AT WINDOW HEAD**

1121 RICHLAND COMMERCE DRIVE; SUITE B  
QUAKERTOWN, PA 18951

Scale 3/4" = 1'-0"

Date: 06/29/21

**KWG-C-ST-03**



DOUBLE LAYER OF 5/8" EXP  
GLASS MAT SHEATHING  
EXTERIOR WALLS ONLY FOR 2  
HR FIRE RATING

SLAB (BY OTHERS)

STRUCTURAL PERIMETER ANGLE  
AND NELSON STUD (BY OTHERS)

DEAD LOAD CLIP AS REQUIRED

FIRESTOPS AT FLOOR LINE NOT  
SHOWN (BY OTHERS)

INTERIOR STRUCTURE  
(BY OTHERS)

COLD ROLLED CHANNEL AS  
REQUIRED

CFMS AS REQUIRED

OPTIONAL NON-FLUID APPLIED  
VAPOR BARRIER OVER  
SHEATHING

WIND LOAD BRACE AS  
REQUIRED

OPTIONAL RIGID INSULATION  
SECURED WITH FASTENER -  
HOLD BACK AS REQ'D

OPTIONAL FIRE TREATED WOOD  
BLOCKING / PLYWOOD  
AS REQUIRED

CLIP AS REQUIRED

OPTIONAL FIRE TREATED WOOD  
BLOCKING / PLYWOOD  
AS REQUIRED

REFERENCE DETAIL ONLY - CONSULT WITH CFMS STRUCTURAL  
ENGINEER FOR SIZING, BRACING AND ATTACHMENT REQUIREMENTS



# SPANDREL PANEL W/SUPPORT BRACE AT WINDOW HEAD 2 HR.

1121 RICHLAND COMMERCE DRIVE; SUITE B  
QUAKERTOWN, PA 18951

Scale 3/4" = 1'-0"

Date: 06/29/21

KWG-C-ST-04

OPTIONAL RIGID INSULATION SECURED WITH FASTENER - HOLD BACK AS REQ'D

5/8" EXP GLASS MAT SHEATHING STANDARD EXTERIOR WALLS ONLY

CFMS AS REQUIRED

COLD ROLLED CHANNEL AS REQUIRED

SLAB (BY OTHERS)

STRUCTURAL PERIMETER ANGLE AND NELSON STUD (BY OTHERS)

DEAD LOAD CLIP AS REQUIRED

FIRESTOPS AT FLOOR LINE NOT SHOWN (BY OTHERS)

OPTIONAL NON-FLUID APPLIED VAPOR BARRIER OVER SHEATHING

INTERIOR STRUCTURE (BY OTHERS)

WIND LOAD BRACE AS REQUIRED

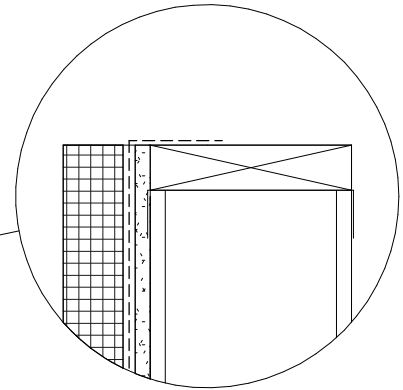

OPTIONAL FIRE TREATED WOOD BLOCKING / PLYWOOD AS REQUIRED

REFERENCE DETAIL ONLY - CONSULT WITH CFMS STRUCTURAL ENGINEER FOR SIZING, BRACING AND ATTACHMENT REQUIREMENTS



## SPANDREL PANEL WITH FIXED CLIP FLOOR SUPPORT

1121 RICHLAND COMMERCE DRIVE; SUITE B  
QUAKERTOWN, PA 18951

Scale 3/4" = 1'-0"

Date: 06/29/21

KWG-C-ST-05

OPTIONAL RIGID INSULATION SECURED WITH FASTENER - HOLD BACK AS REQ'D

DOUBLE LAYER OF 5/8" EXP GLASS MAT SHEATHING EXTERIOR WALLS ONLY FOR 2 HR FIRE RATING

CFMS AS REQUIRED

COLD ROLLED CHANNEL AS REQUIRED

SLAB (BY OTHERS)

STRUCTURAL PERIMETER ANGLE AND NELSON STUD (BY OTHERS)

DEAD LOAD CLIP AS REQUIRED

FIRESTOPS AT FLOOR LINE NOT SHOWN (BY OTHERS)

OPTIONAL NON-FLUID APPLIED VAPOR BARRIER OVER SHEATHING

INTERIOR STRUCTURE (BY OTHERS)

WIND LOAD BRACE AS REQUIRED

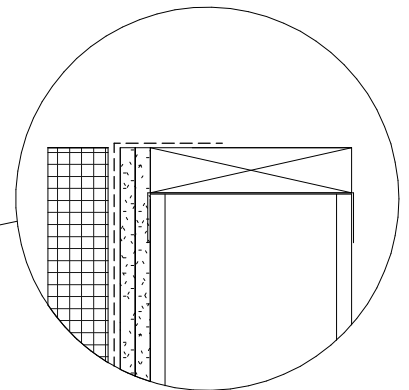

OPTIONAL FIRE TREATED WOOD BLOCKING / PLYWOOD AS REQUIRED

REFERENCE DETAIL ONLY - CONSULT WITH CFMS STRUCTURAL ENGINEER FOR SIZING, BRACING AND ATTACHMENT REQUIREMENTS



# SPANDREL PANEL WITH FIXED CLIP FLOOR SUPPORT 2 HR.

1121 RICHLAND COMMERCE DRIVE; SUITE B  
QUAKERTOWN, PA 18951

Scale 3/4" = 1'-0"

Date: 06/29/21

KWG-C-ST-06

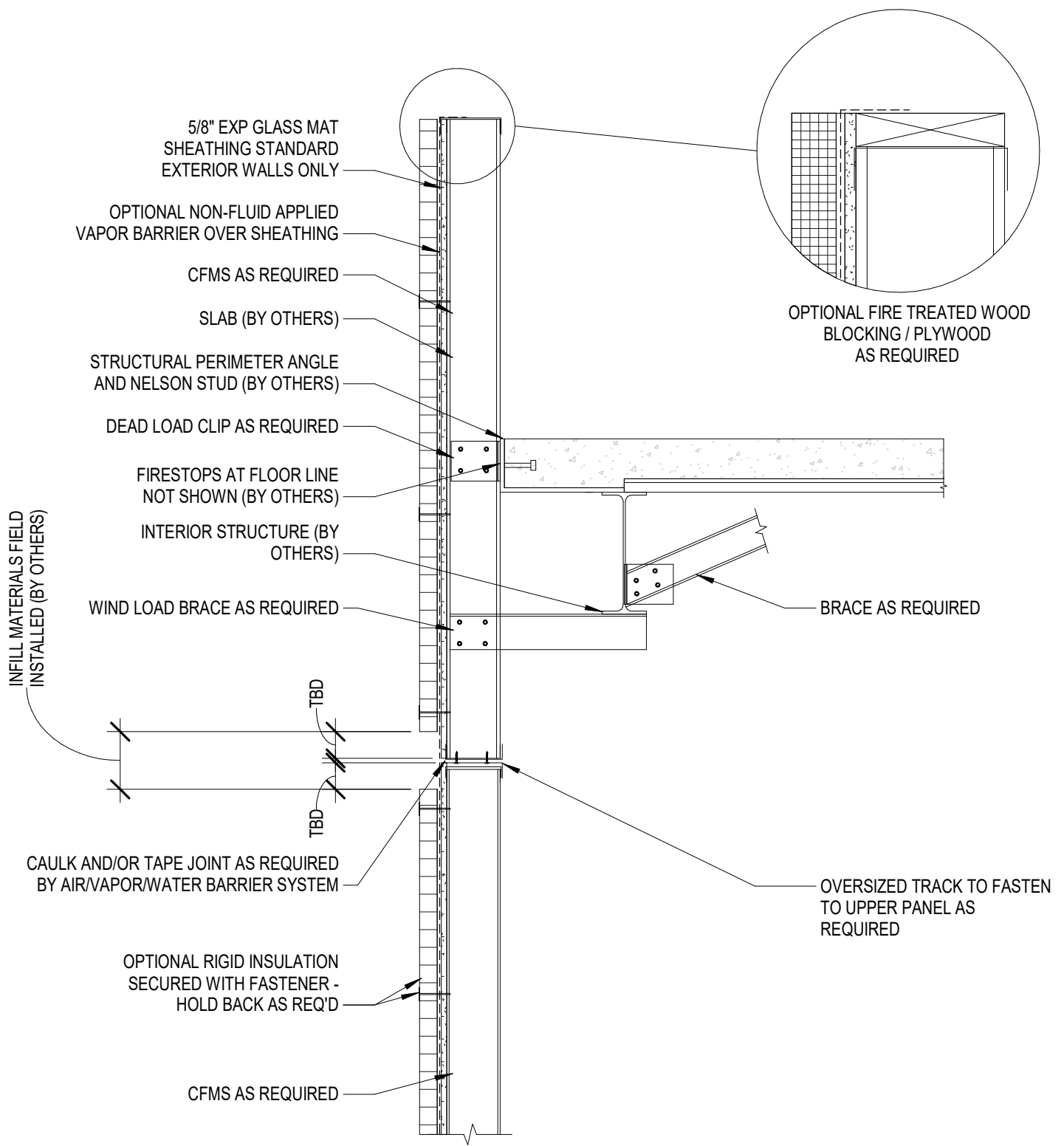

REFERENCE DETAIL ONLY - CONSULT WITH CFMS STRUCTURAL ENGINEER FOR SIZING, BRACING AND ATTACHMENT REQUIREMENTS



# SPANDREL PANEL WITH INFILL WINDOWS

1121 RICHLAND COMMERCE DRIVE; SUITE B  
QUAKERTOWN, PA 18951

Scale 3/4" = 1'-0"

Date: 06/29/21

KWG-C-ST-07

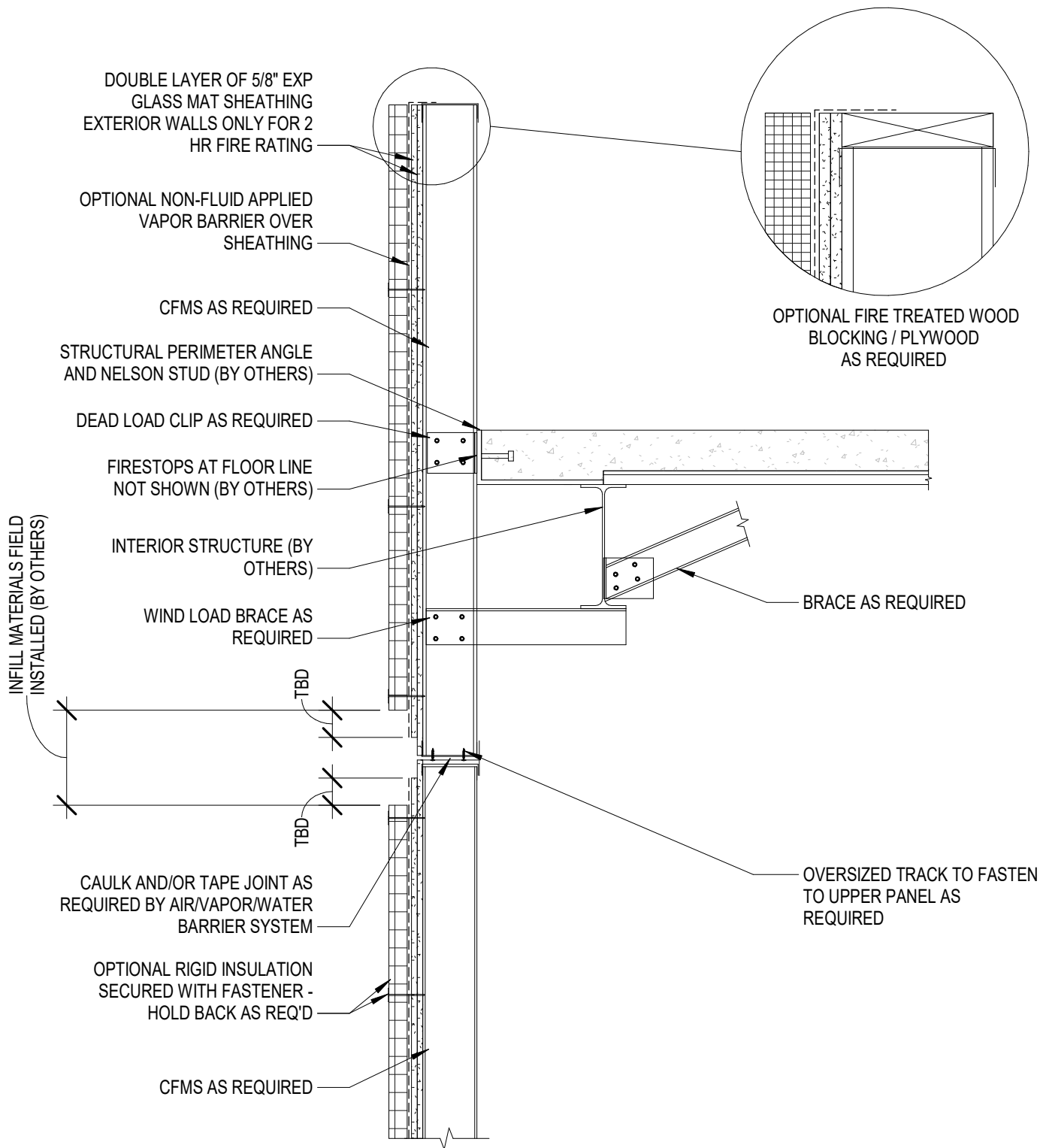

REFERENCE DETAIL ONLY - CONSULT WITH CFMS STRUCTURAL ENGINEER FOR SIZING, BRACING AND ATTACHMENT REQUIREMENTS



**SPANDREL PANEL WITH INFILL WINDOWS 2 HR.**

1121 RICHLAND COMMERCE DRIVE; SUITE B  
QUAKERTOWN, PA 18951

Scale 3/4" = 1'-0"

Date: 06/29/21

**KWG-C-ST-08**

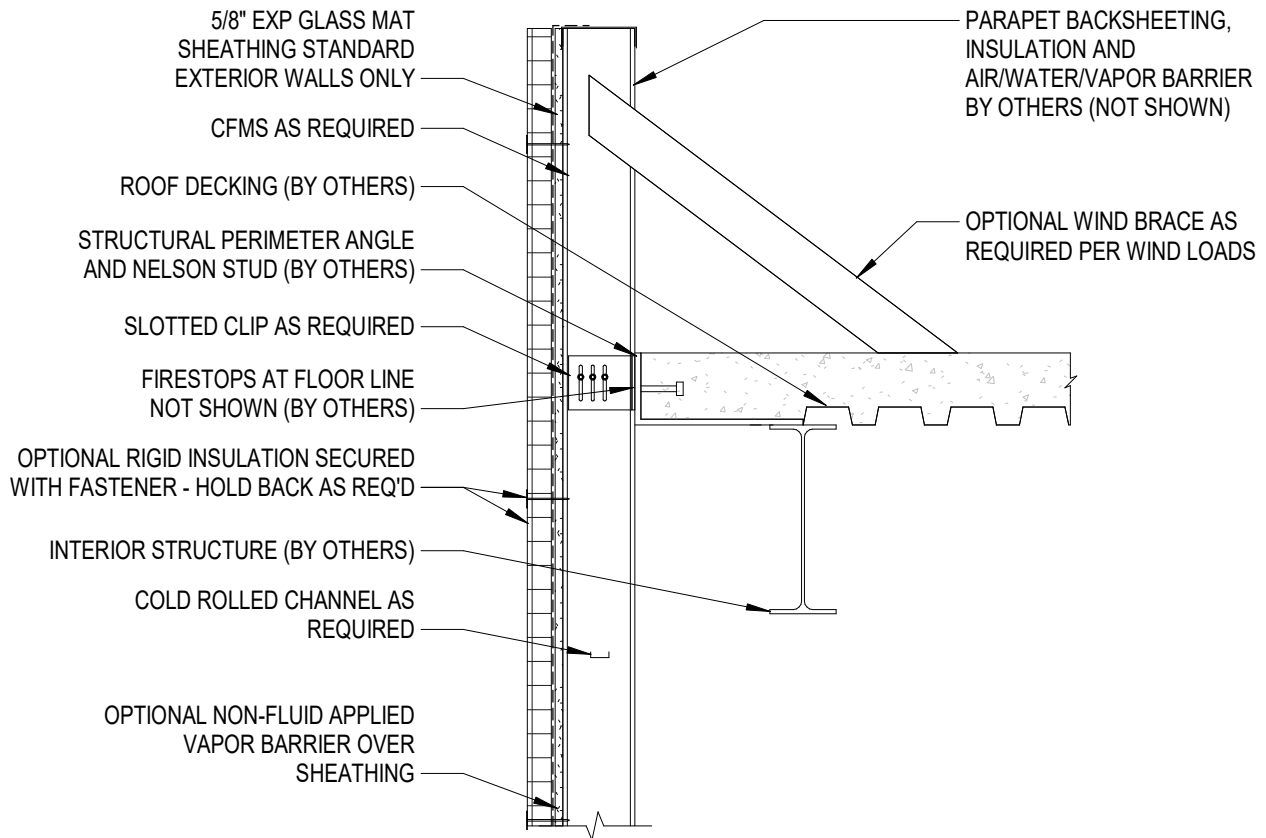

REFERENCE DETAIL ONLY - CONSULT WITH CFMS STRUCTURAL ENGINEER FOR SIZING, BRACING AND ATTACHMENT REQUIREMENTS

**KLOVER**

**PARAPET WITH FOUNDATION SUPPORTED WALL PANEL**

1121 RICHLAND COMMERCE DRIVE; SUITE B  
QUAKERTOWN, PA 18951

Scale 3/4" = 1'-0"

Date: 06/29/21

**KWG-C-ST-09**

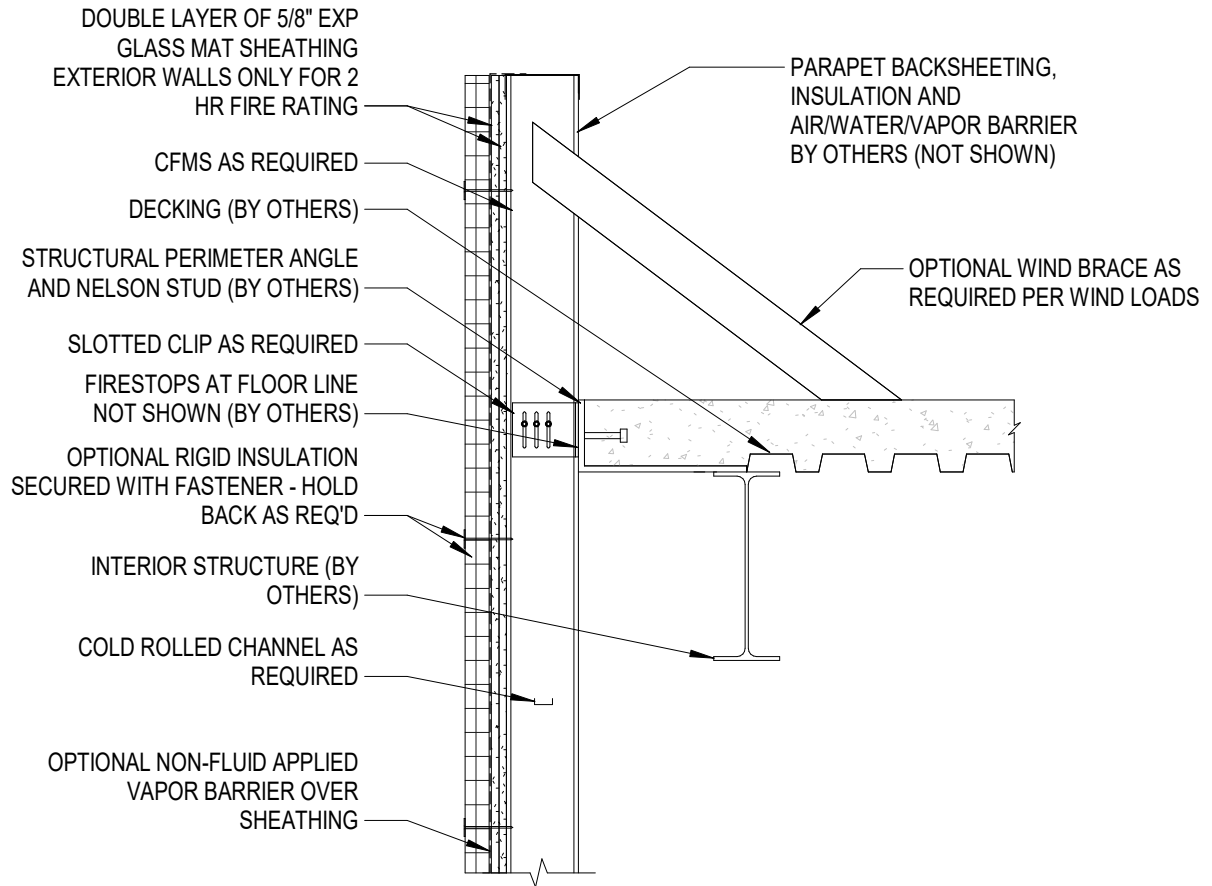

REFERENCE DETAIL ONLY - CONSULT WITH CFMS STRUCTURAL ENGINEER FOR SIZING, BRACING AND ATTACHMENT REQUIREMENTS



**PARAPET WITH FOUNDATION SUPPORTED WALL PANEL 2 HR.**

1121 RICHLAND COMMERCE DRIVE; SUITE B  
QUAKERTOWN, PA 18951

Scale 3/4" = 1'-0"

Date: 06/29/21

**KWG-C-ST-10**

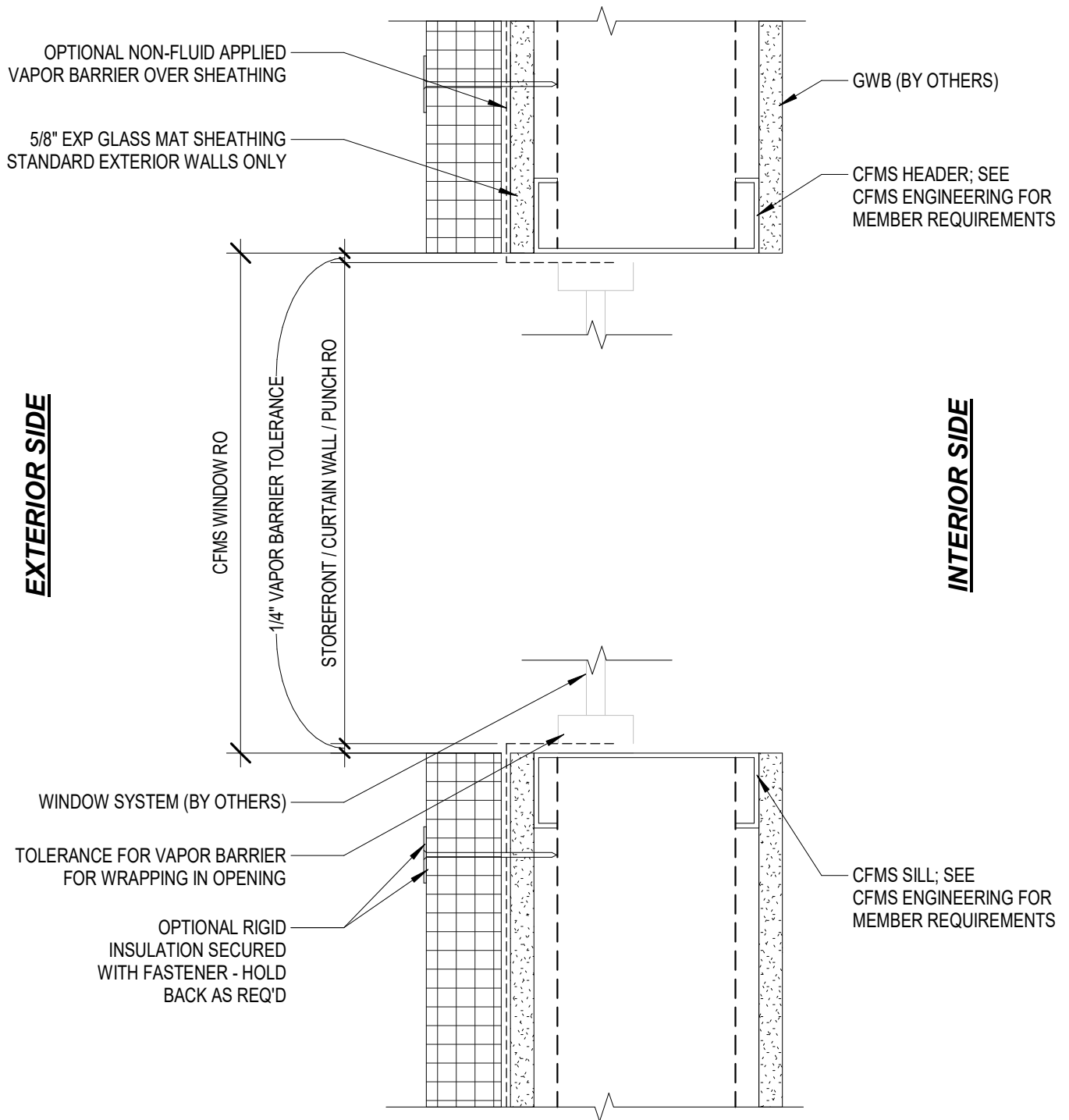

**\*WINDOW SHOP DRAWINGS REQUIRED  
PRIOR TO PANEL FABRICATION**

**KLOVER**

**WINDOW HEADER & SILL DETAIL**

1121 RICHLAND COMMERCE DRIVE; SUITE B  
QUAKERTOWN, PA 18951

Scale 3" = 1'-0"

Date: 06/29/21

**KWG-C-FO-01**



**EXTERIOR SIDE**

**INTERIOR SIDE**

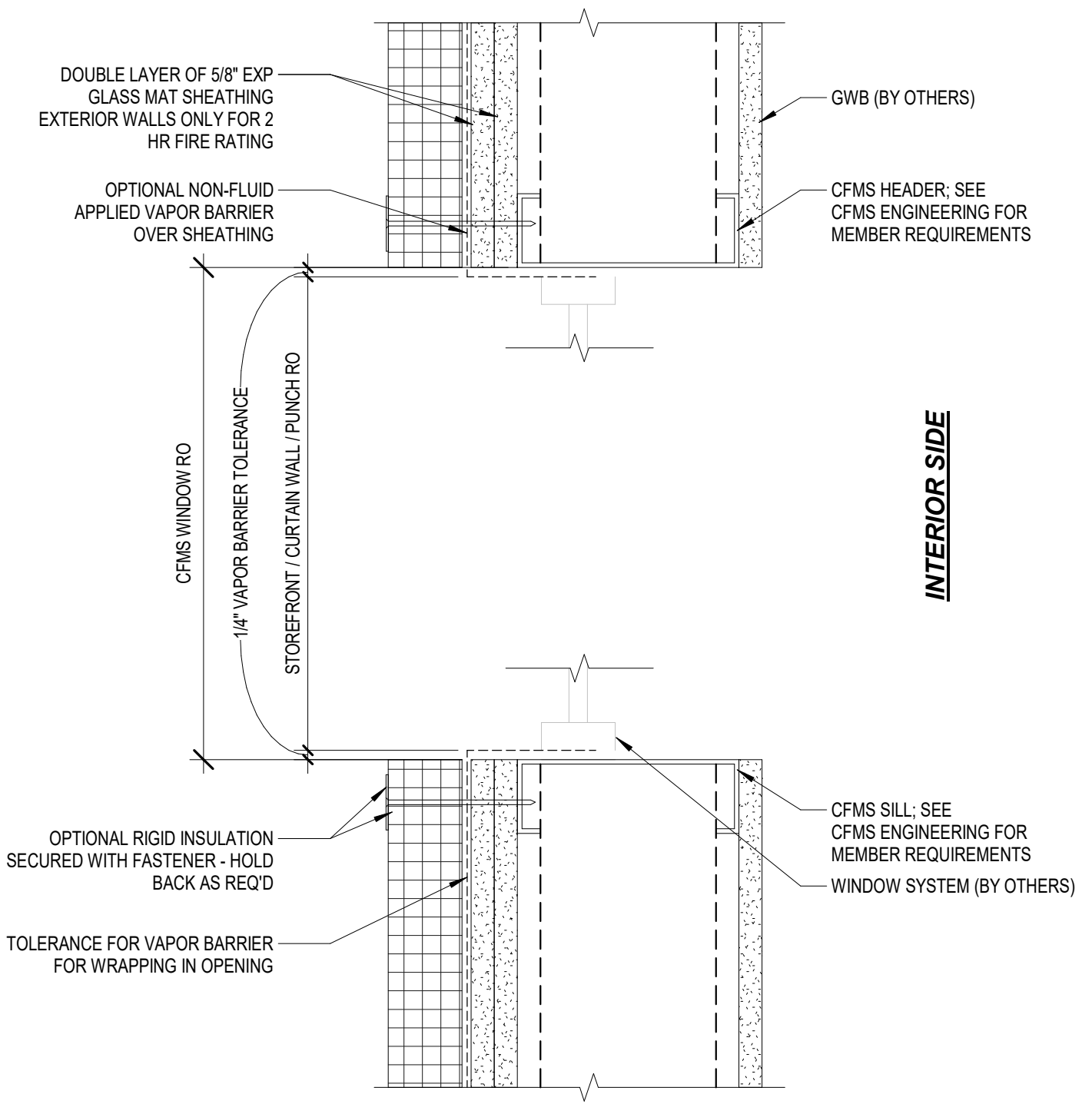

**\*WINDOW SHOP DRAWINGS REQUIRED  
PRIOR TO PANEL FABRICATION**



# WINDOW HEADER & SILL DETAIL 2 HR.

1121 RICHLAND COMMERCE DRIVE; SUITE B  
QUAKERTOWN, PA 18951

Scale 3" = 1'-0"

Date: 06/29/21

**KWG-C-FO-02**

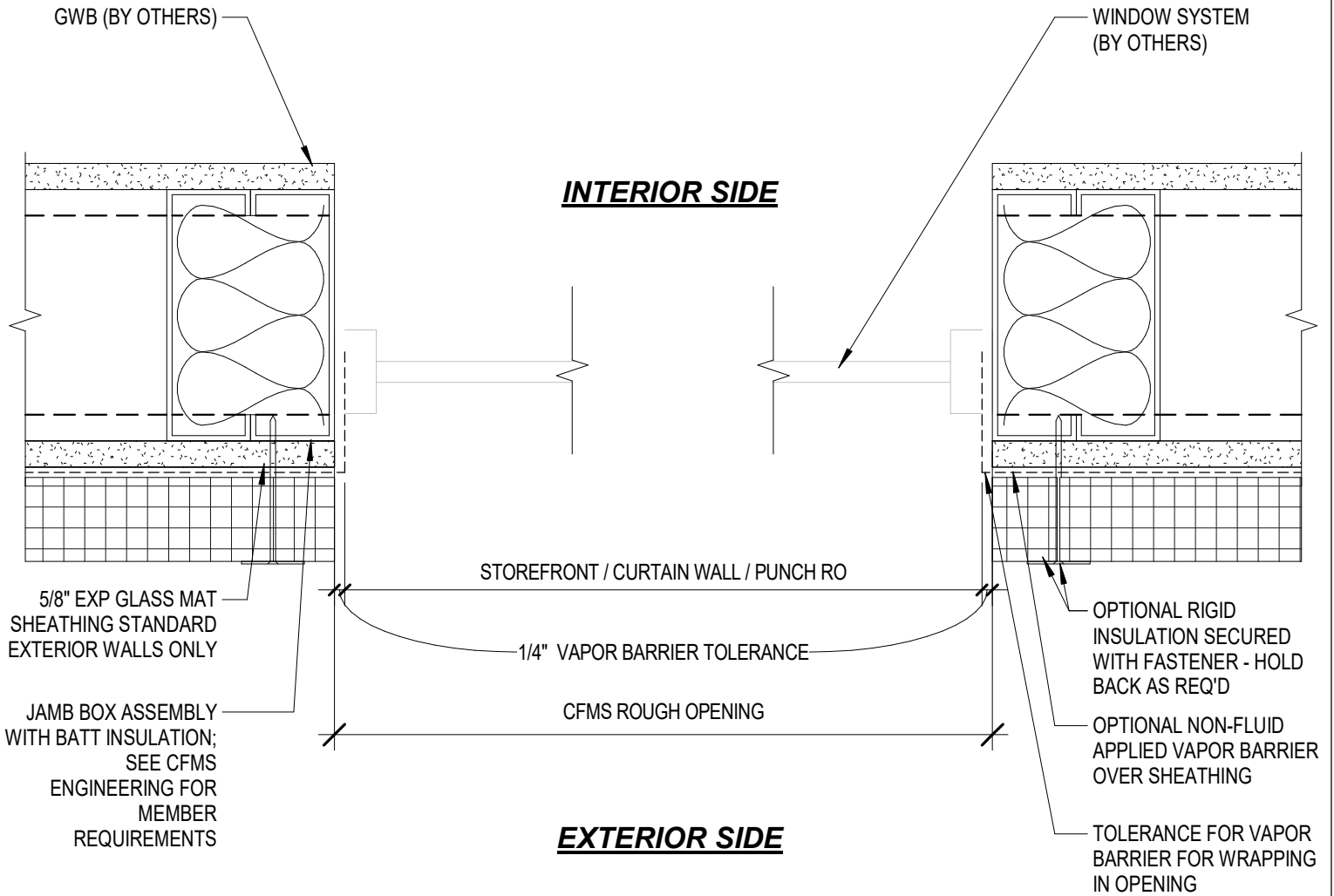

**\*WINDOW SHOP DRAWINGS REQUIRED PRIOR TO PANEL FABRICATION**



## WINDOW JAMB

1121 RICHLAND COMMERCE DRIVE; SUITE B  
QUAKERTOWN, PA 18951

Scale 3" = 1'-0"

Date: 06/29/21

**KWG-C-FO-03**

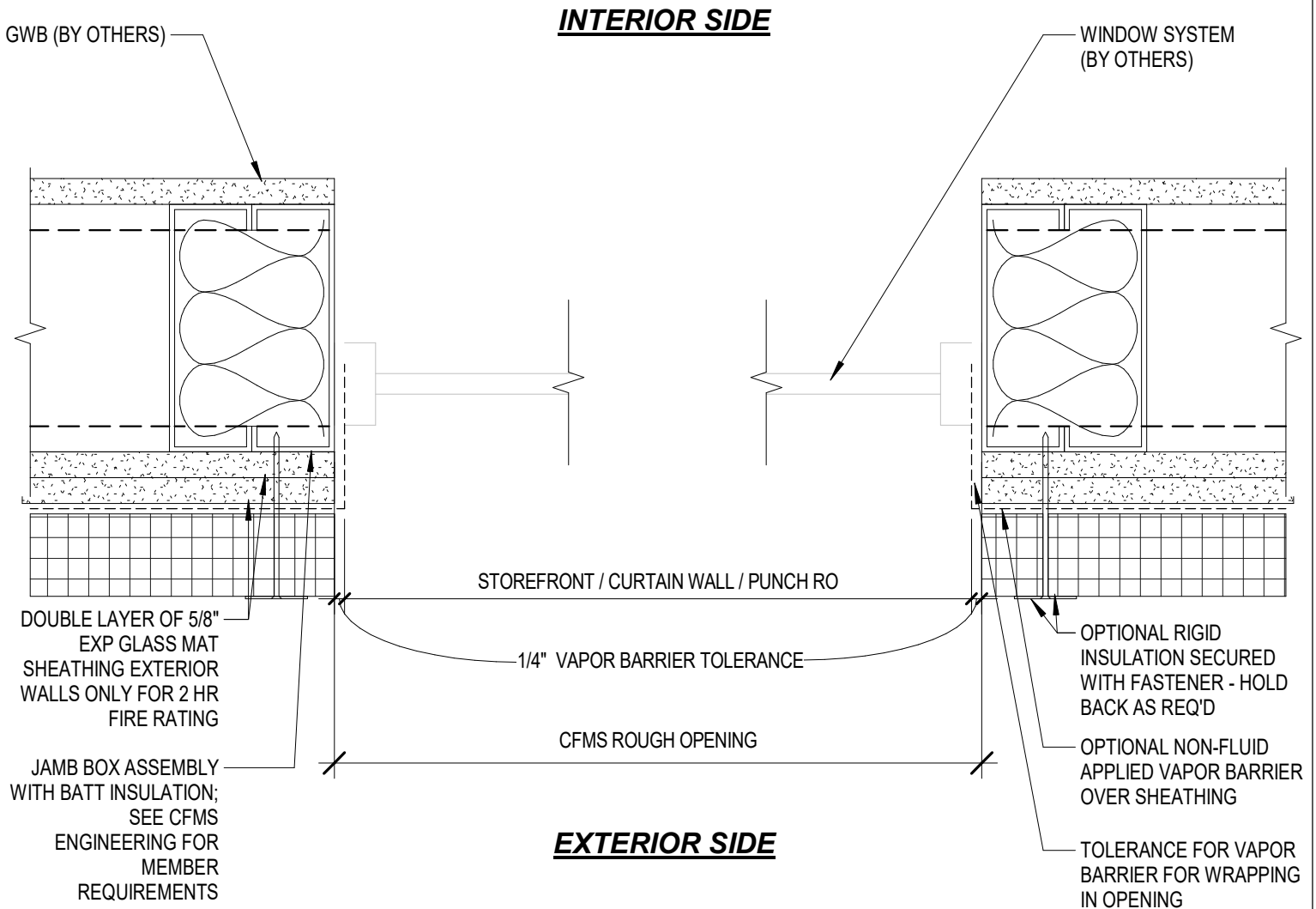

**\*WINDOW SHOP DRAWINGS REQUIRED PRIOR TO PANEL FABRICATION**



**WINDOW JAMB 2 HR.**

1121 RICHLAND COMMERCE DRIVE; SUITE B  
QUAKERTOWN, PA 18951

Scale 3" = 1'-0"

Date: 06/29/21

**KWG-C-FO-04**

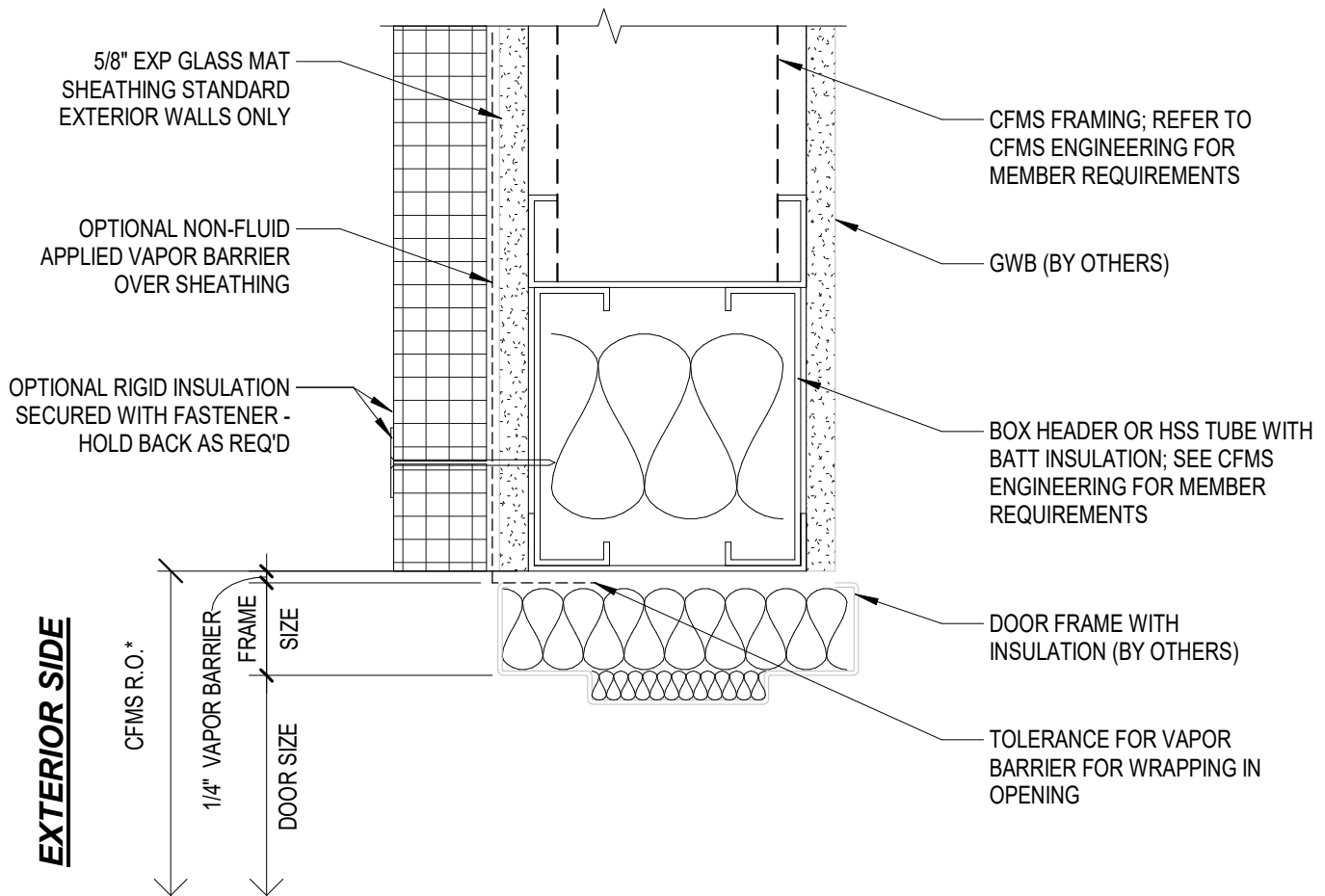

\*DOOR SHOP DRAWINGS REQUIRED PRIOR TO PANEL FABRICATION



## DOOR HEADER

1121 RICHLAND COMMERCE DRIVE; SUITE B  
QUAKERTOWN, PA 18951

Scale 3" = 1'-0"

Date: 06/29/21

KWG-C-FO-05

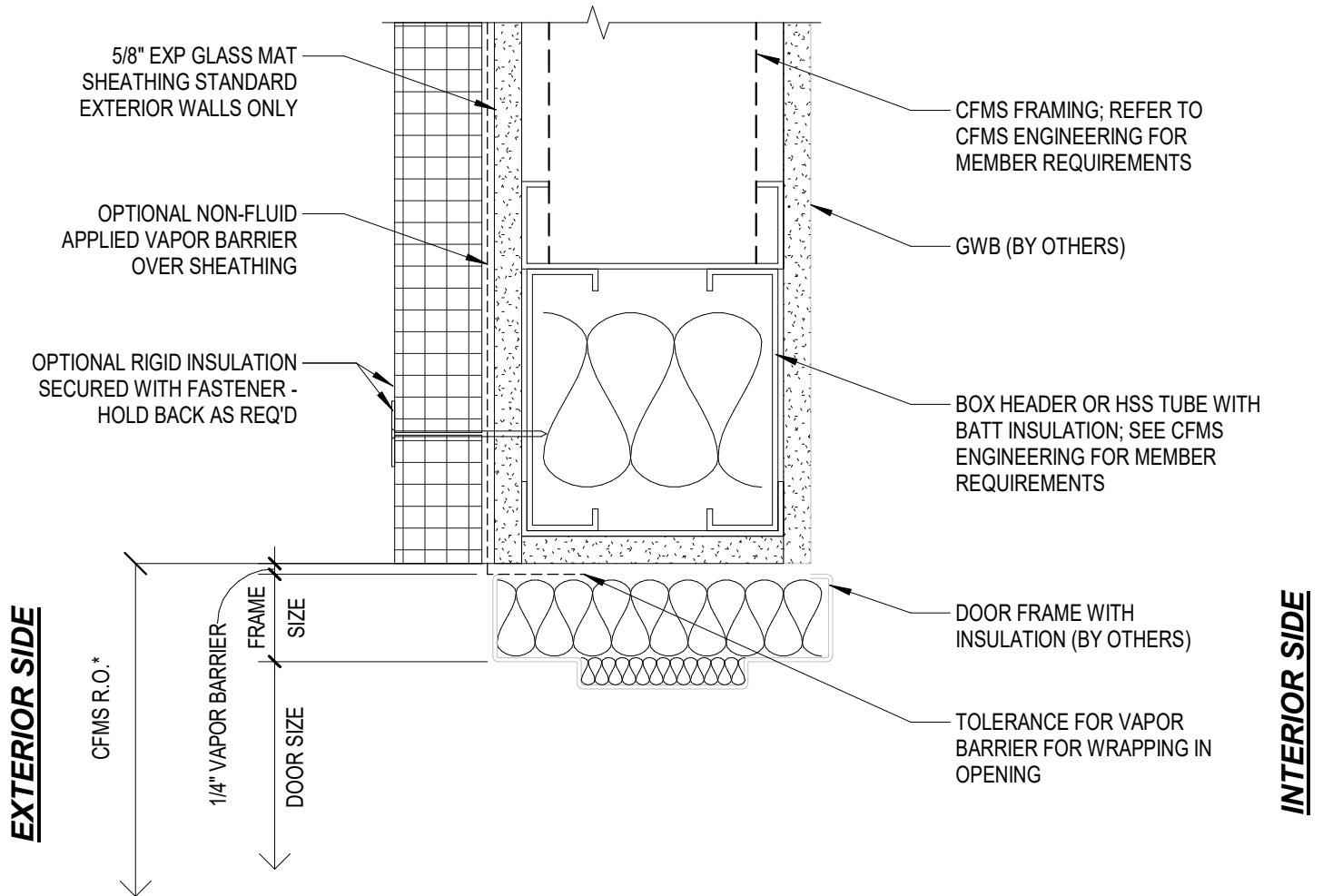

**\*DOOR SHOP DRAWINGS REQUIRED PRIOR TO PANEL FABRICATION**



**DOOR HEADER ALTERNATE**

1121 RICHLAND COMMERCE DRIVE; SUITE B  
QUAKERTOWN, PA 18951

Scale 3" = 1'-0"

Date: 06/29/21

**KWG-C-FO-06**

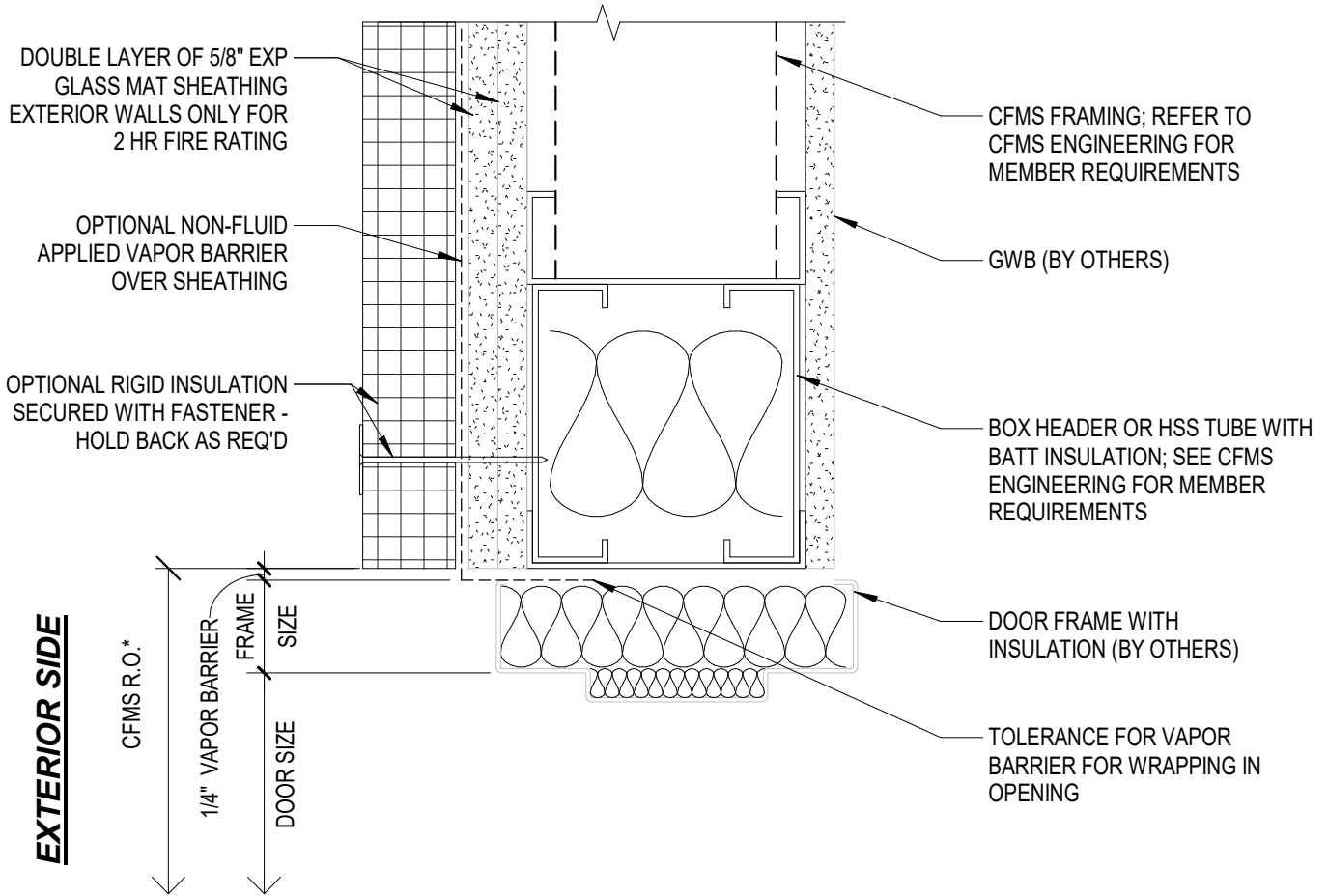

\*DOOR SHOP DRAWINGS REQUIRED PRIOR TO PANEL FABRICATION



**DOOR HEADER 2 HR.**

1121 RICHLAND COMMERCE DRIVE; SUITE B  
QUAKERTOWN, PA 18951

Scale 3" = 1'-0"

Date: 06/29/21

**KWG-C-FO-07**

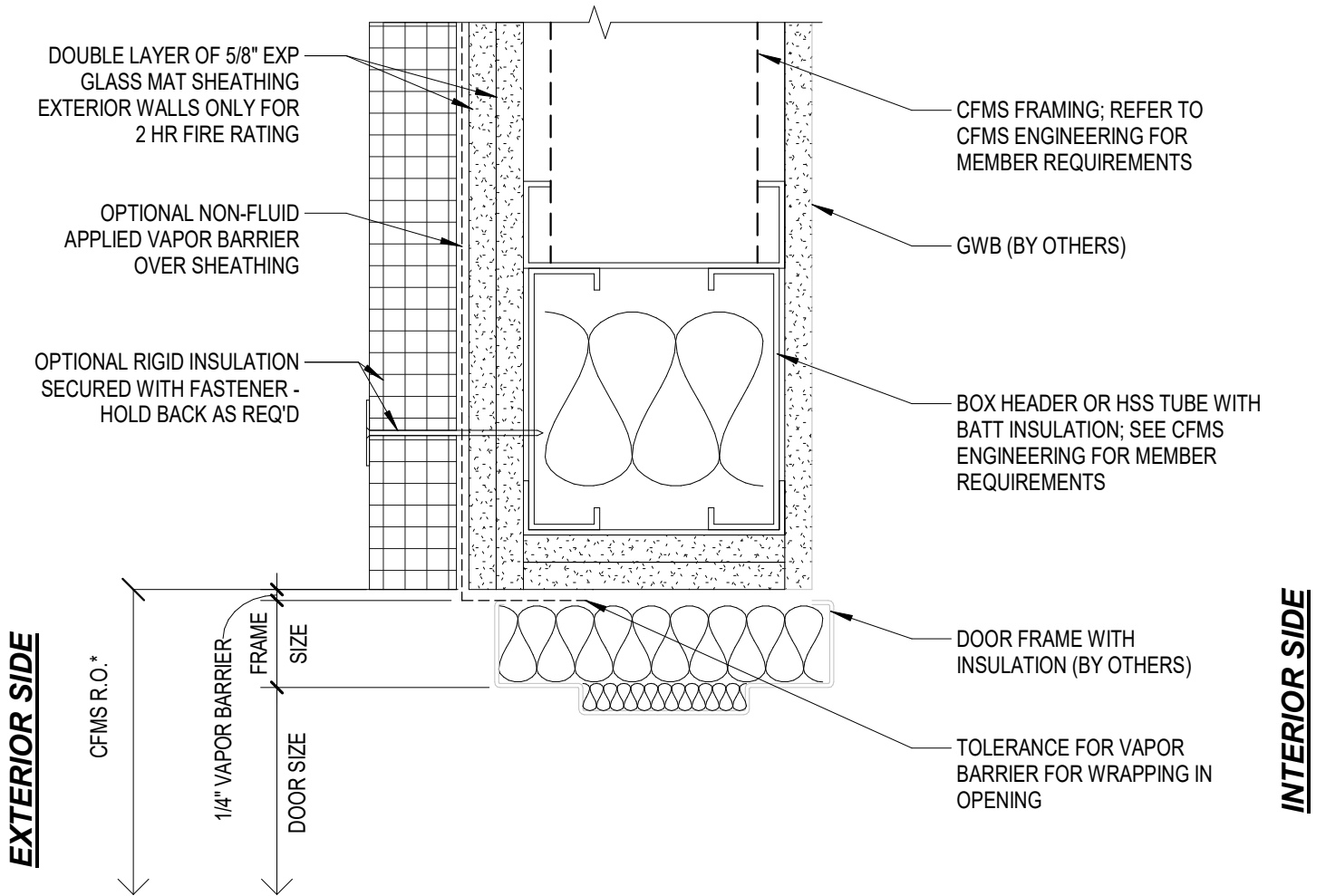

**\*DOOR SHOP DRAWINGS REQUIRED PRIOR TO PANEL FABRICATION**



**DOOR HEADER 2 HR. ALTERNATE**

1121 RICHLAND COMMERCE DRIVE; SUITE B  
QUAKERTOWN, PA 18951

Scale 3" = 1'-0"

Date: 06/29/21

**KWG-C-FO-08**

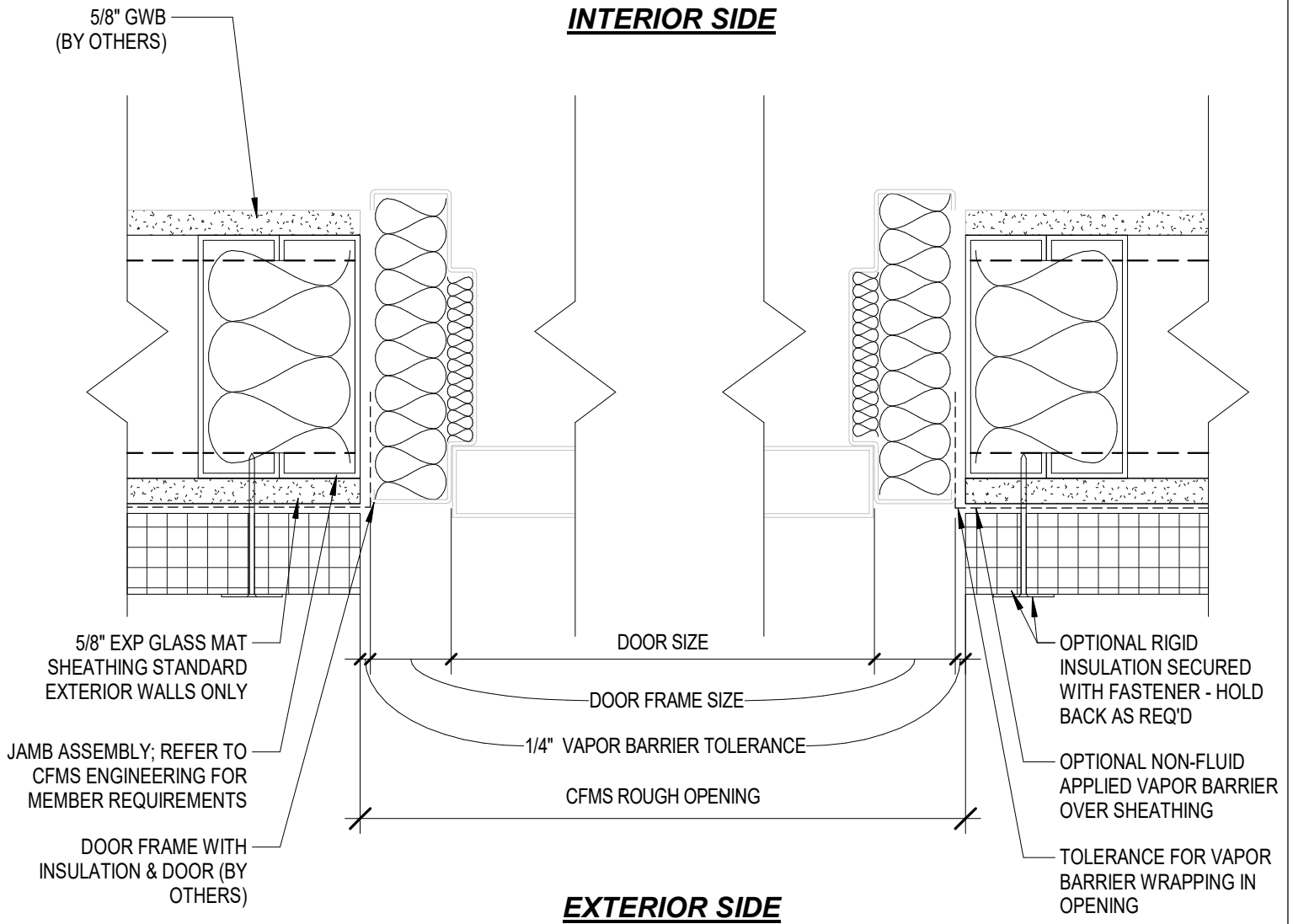

**\*DOOR SHOP DRAWINGS REQUIRED PRIOR TO PANEL FABRICATION**



**DOOR JAMB**

1121 RICHLAND COMMERCE DRIVE; SUITE B  
QUAKERTOWN, PA 18951

Scale 3" = 1'-0"

Date: 06/29/21

**KWG-C-FO-09**



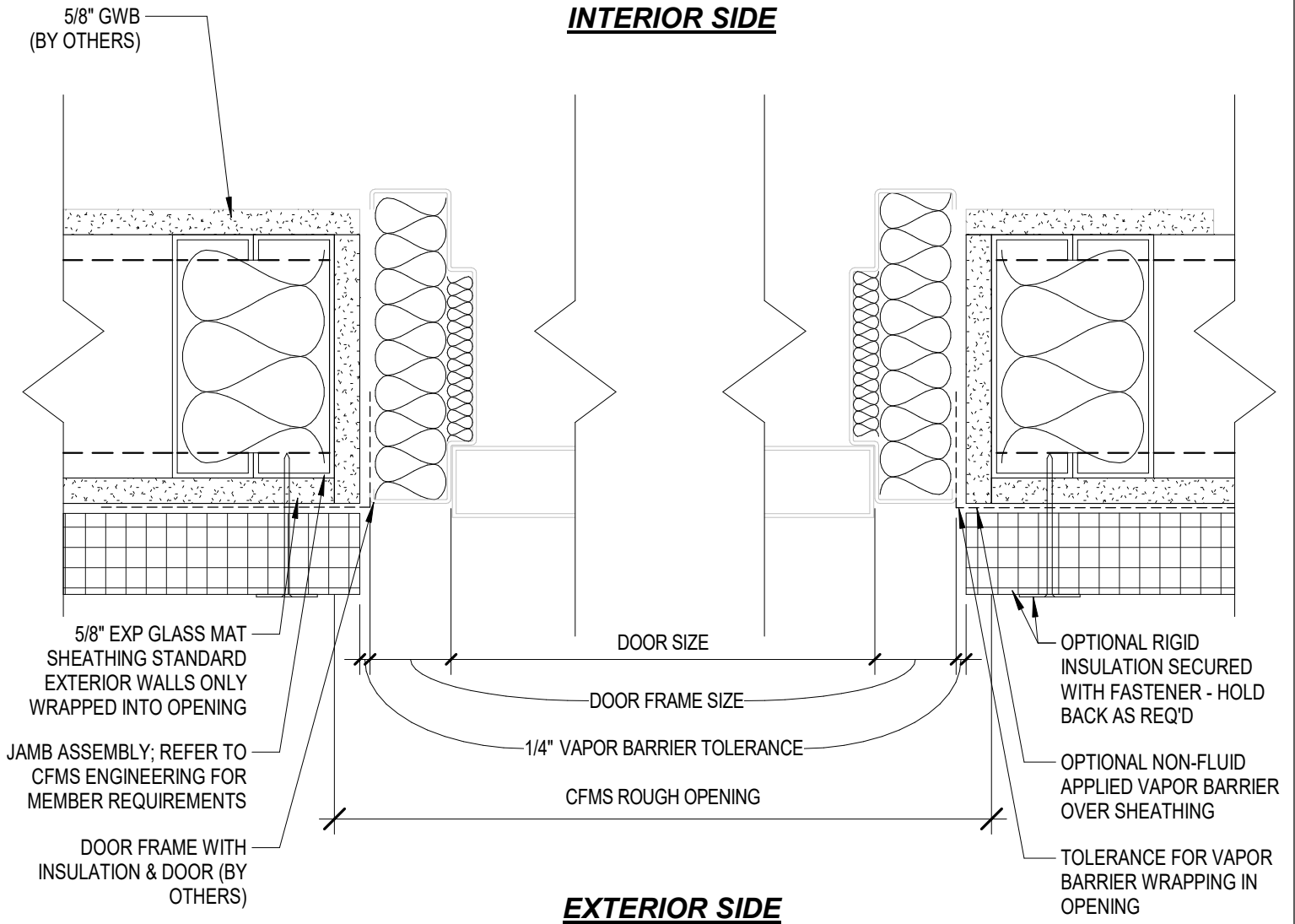

**\*DOOR SHOP DRAWINGS REQUIRED PRIOR TO PANEL FABRICATION**



**DOOR JAMB ALTERNATE**

1121 RICHLAND COMMERCE DRIVE; SUITE B  
QUAKERTOWN, PA 18951

Scale 3" = 1'-0"

Date: 06/29/21

**KWG-C-FO-10**

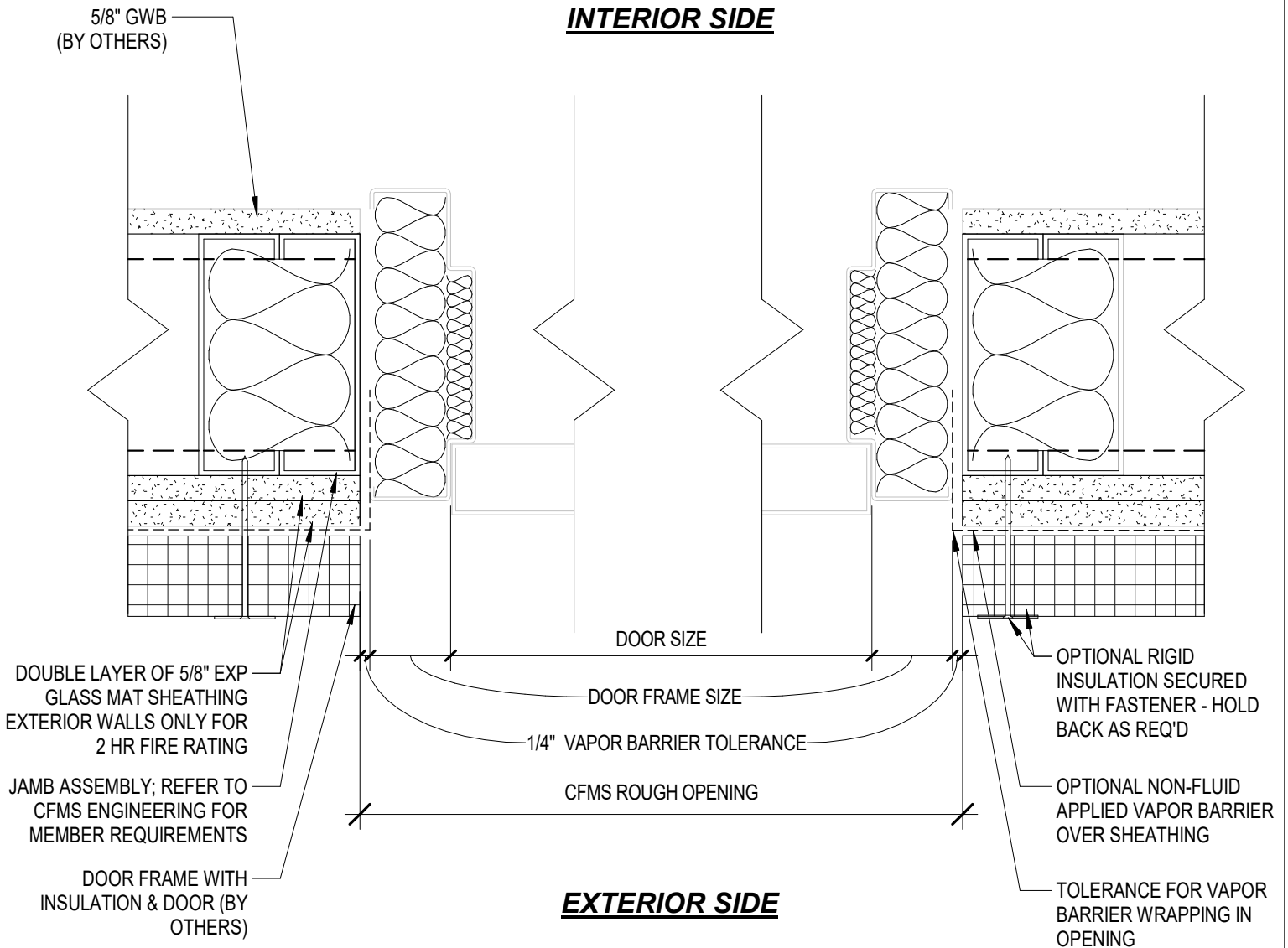

**\*DOOR SHOP DRAWINGS REQUIRED PRIOR TO PANEL FABRICATION**



**DOOR JAMB 2 HR.**

1121 RICHLAND COMMERCE DRIVE; SUITE B  
QUAKERTOWN, PA 18951

Scale 3" = 1'-0"

Date: 06/29/21

**KWG-C-FO-11**

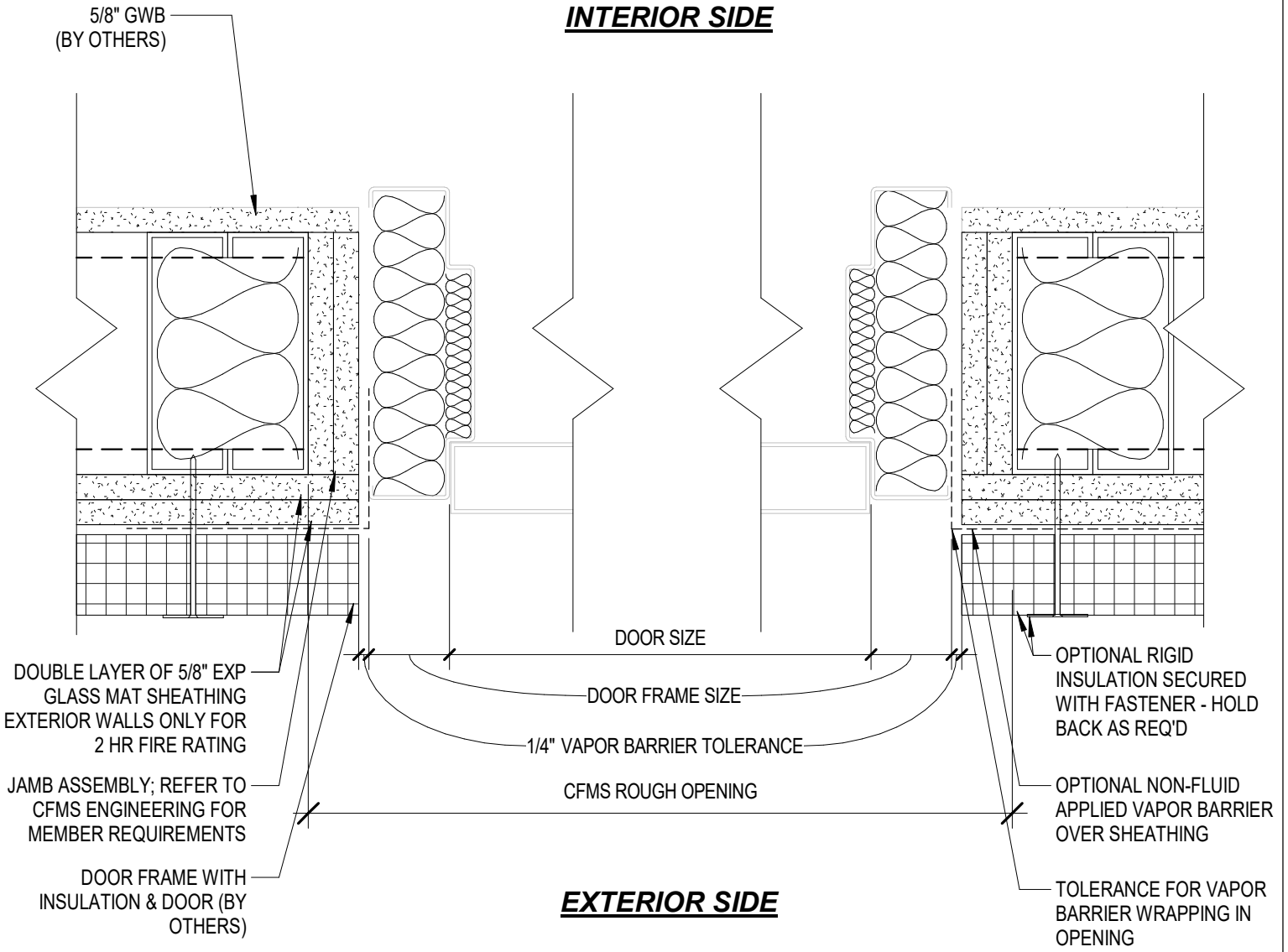

**\*DOOR SHOP DRAWINGS REQUIRED PRIOR TO PANEL FABRICATION**



**DOOR JAMB 2 HR. ALTERNATE**

1121 RICHLAND COMMERCE DRIVE; SUITE B  
QUAKERTOWN, PA 18951

Scale 3" = 1'-0"

Date: 06/29/21

**KWG-C-FO-12**

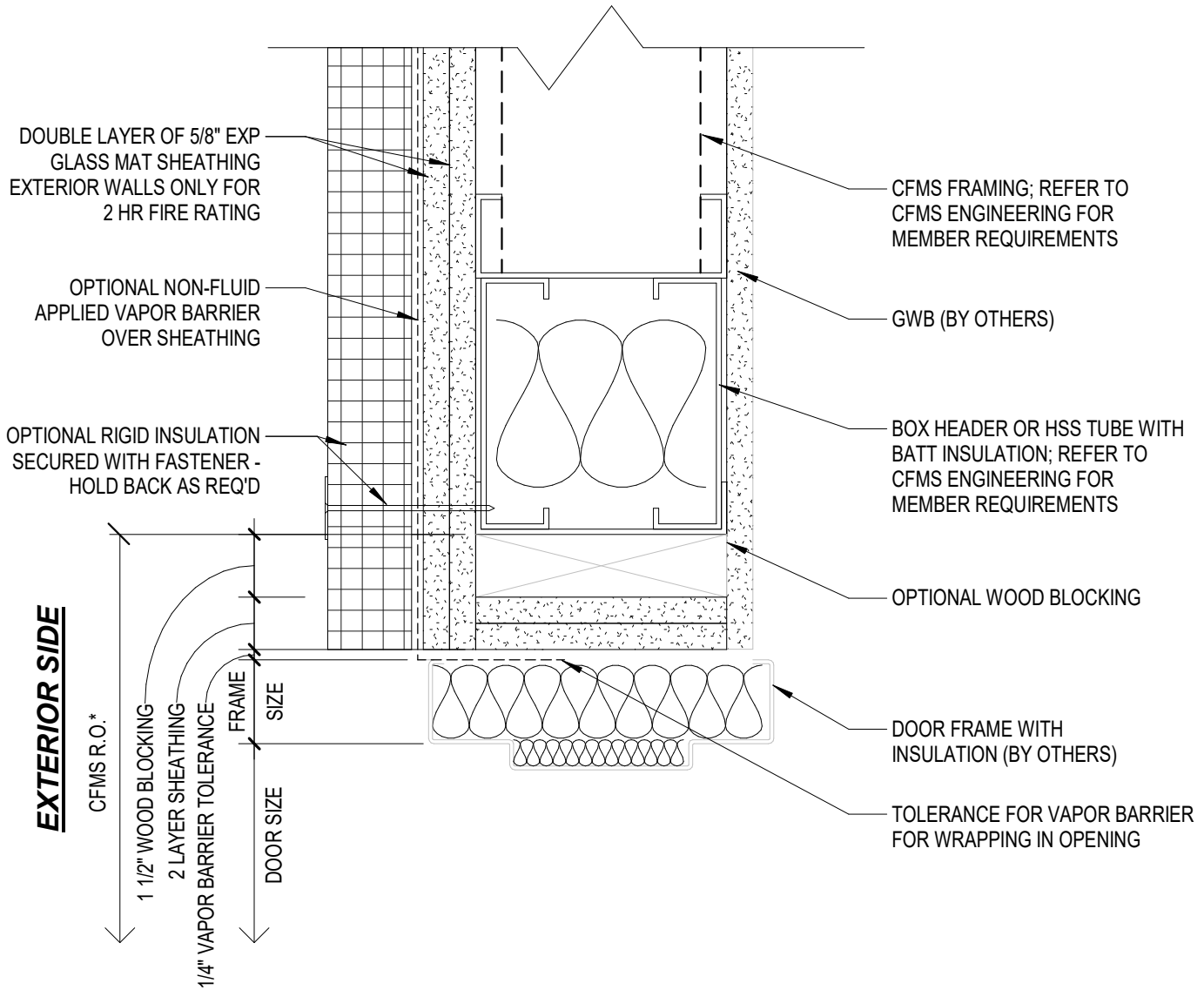

**\*DOOR SHOP DRAWINGS REQUIRED PRIOR TO PANEL FABRICATION**



**DOOR HEADER WITH BLOCKING  
2 HR. ALTERNATE**

1121 RICHLAND COMMERCE DRIVE; SUITE B  
QUAKERTOWN, PA 18951

Scale 3" = 1'-0"

Date: 06/29/21

**KWG-C-FO-13**

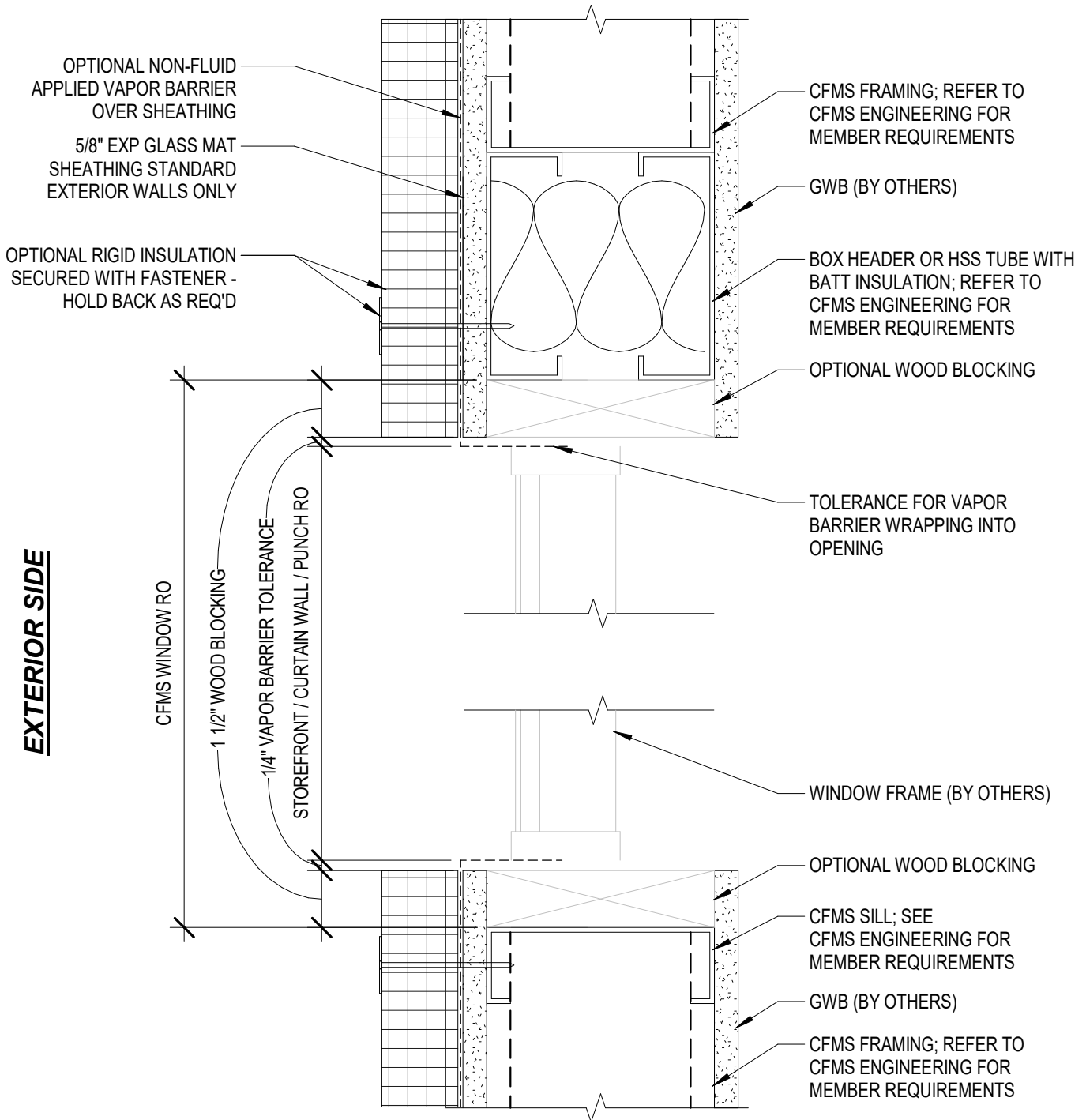

**\*WINDOW SHOP DRAWINGS REQUIRED PRIOR TO PANEL FABRICATION**



**WINDOW BOXED HEAD & SILL WITH BLOCKING**

1121 RICHLAND COMMERCE DRIVE; SUITE B  
QUAKERTOWN, PA 18951

Scale 3" = 1'-0"

Date: 06/29/21

**KWG-C-FO-14**

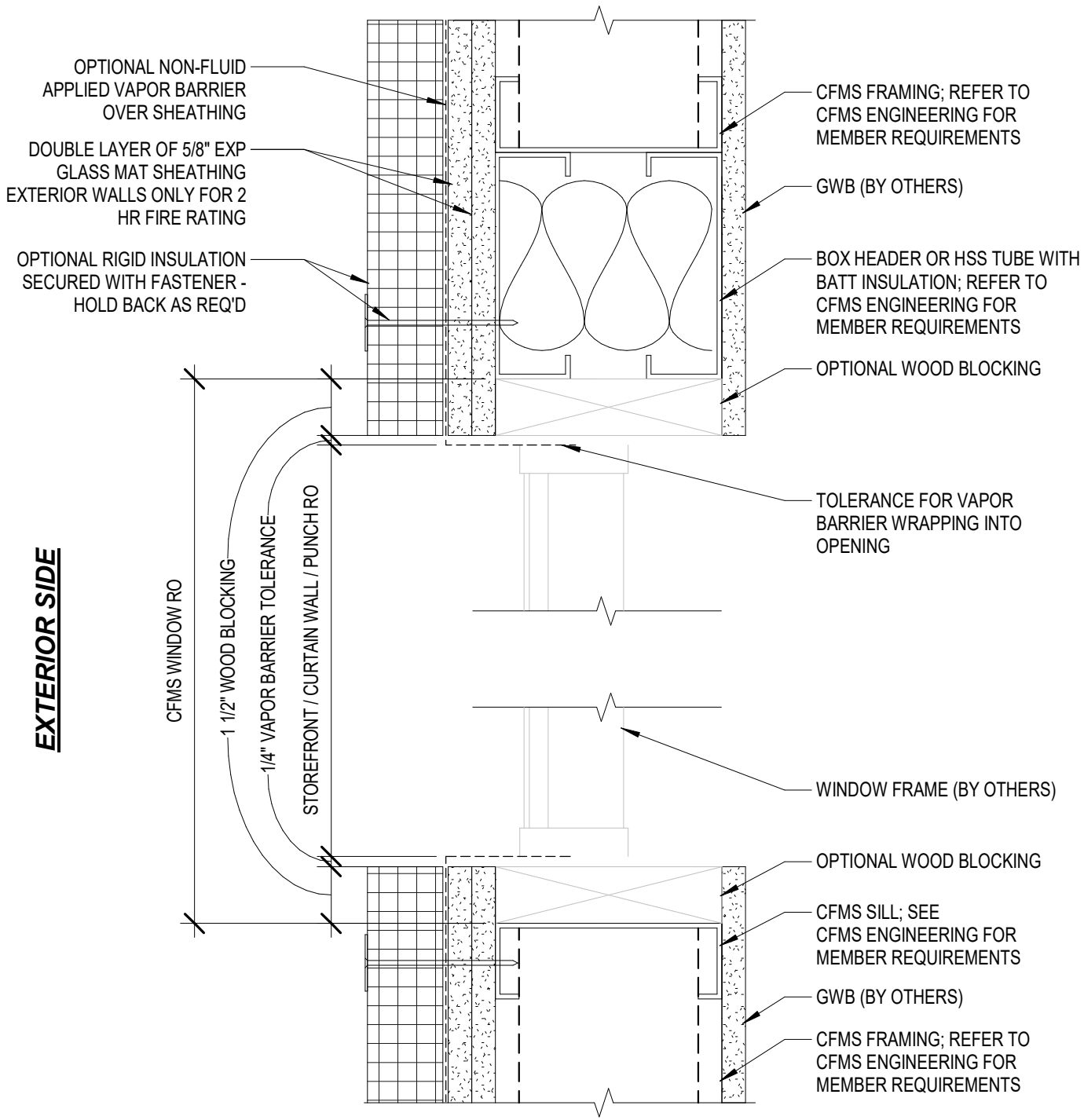

**\*WINDOW SHOP DRAWINGS REQUIRED  
PRIOR TO PANEL FABRICATION**

	<b>WINDOW BOXED HEAD &amp; SILL WITH BLOCKING 2 HR.</b>	
	1121 RICHLAND COMMERCE DRIVE; SUITE B QUAKERTOWN, PA 18951	Scale 3" = 1'-0" Date: 06/29/21

**INTERIOR SIDE**

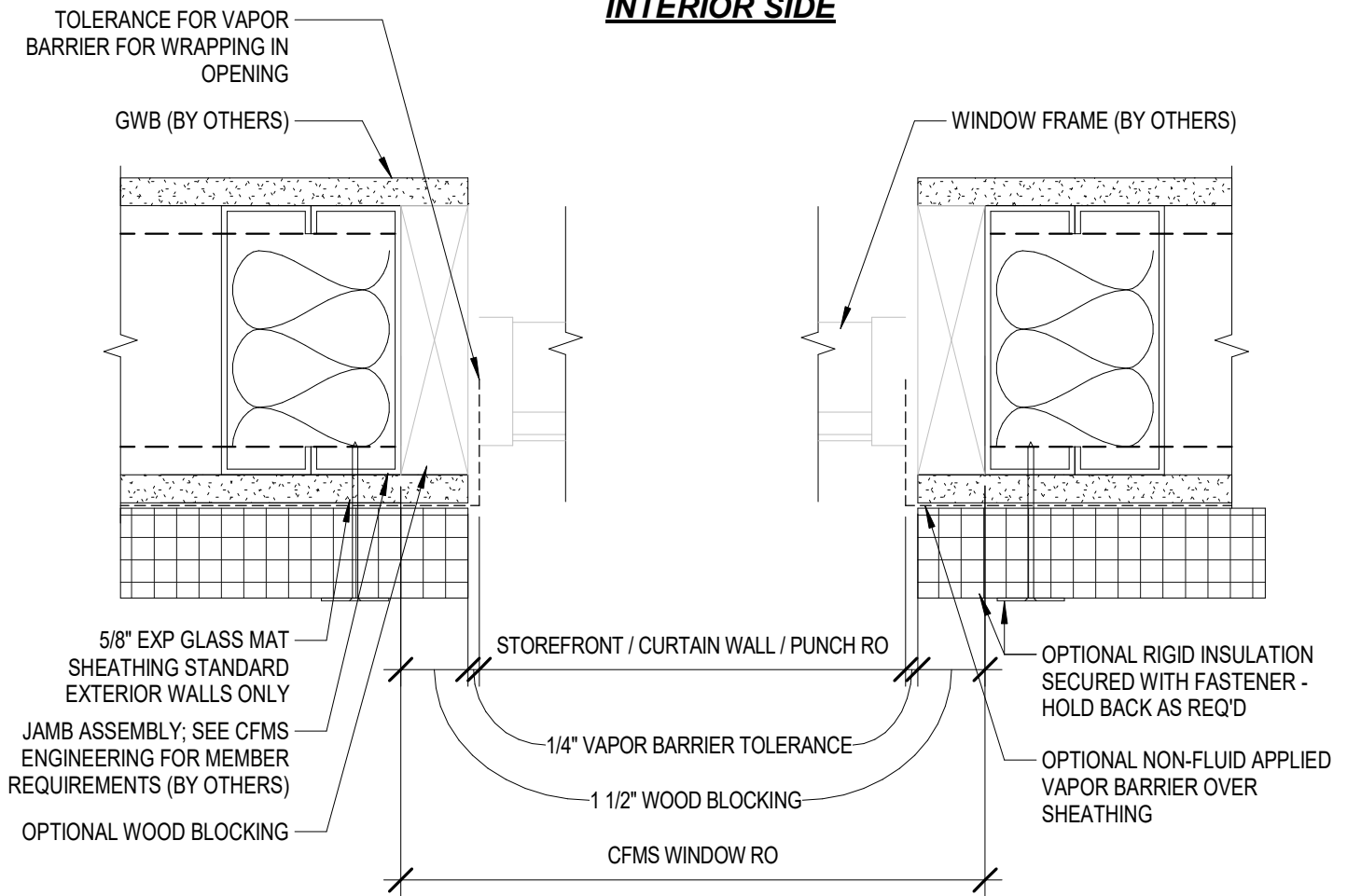

**EXTERIOR SIDE**

**\*WINDOW SHOP DRAWINGS REQUIRED PRIOR TO PANEL FABRICATION**

**KLOVER**

**WINDOW & CURTAIN WALL JAMB WITH BLOCKING**

1121 RICHLAND COMMERCE DRIVE; SUITE B  
QUAKERTOWN, PA 18951

Scale 3" = 1'-0"

Date: 06/29/21

**KWG-C-FO-16**

**INTERIOR SIDE**

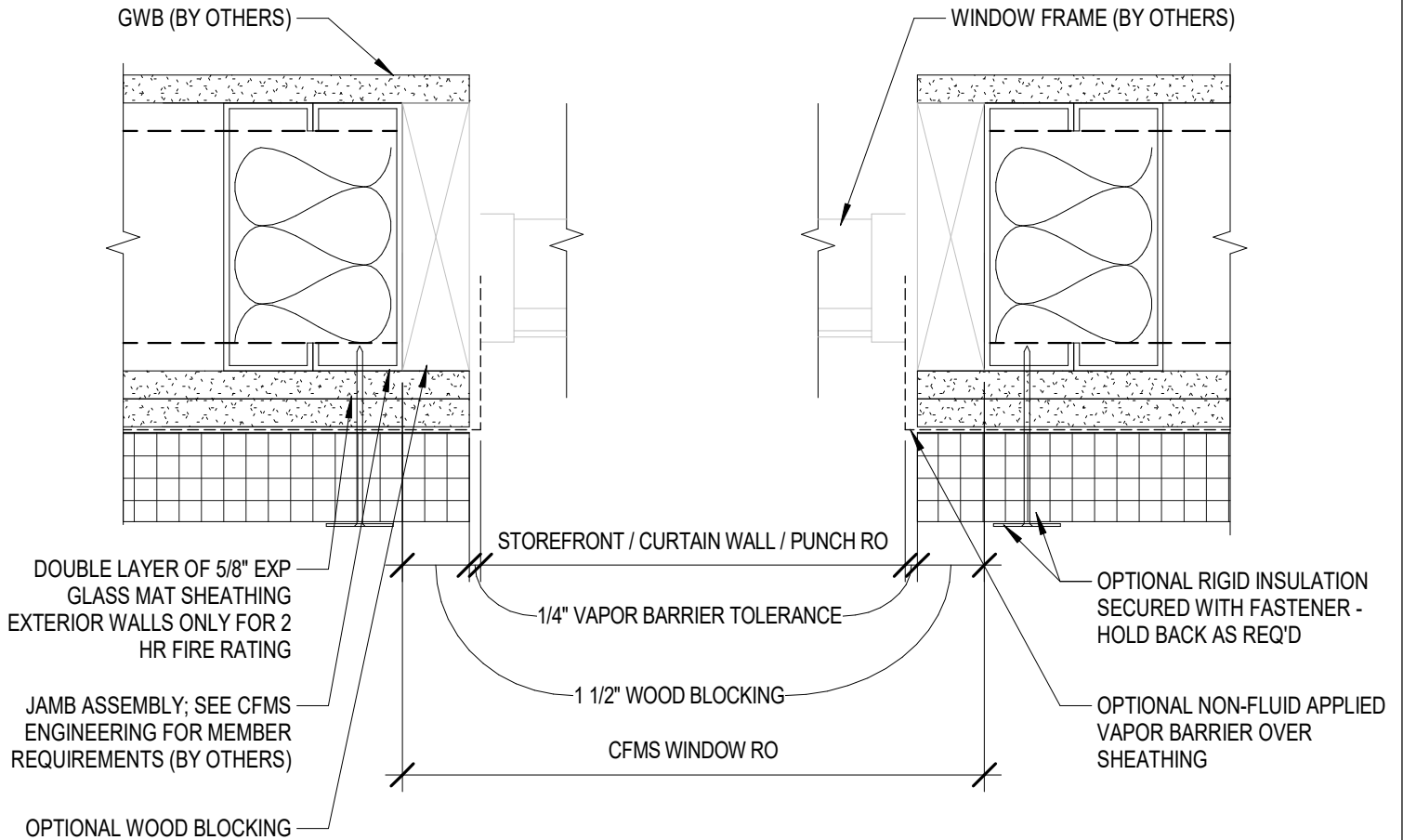

**EXTERIOR SIDE**

**\*WINDOW SHOP DRAWINGS REQUIRED  
PRIOR TO PANEL FABRICATION**

**KLOVER**

**WINDOW & CURTAIN WALL JAMB  
WITH BLOCKING 2 HR.**

1121 RICHLAND COMMERCE DRIVE; SUITE B  
QUAKERTOWN, PA 18951

Scale 3" = 1'-0"

Date:

06/29/21

**KWG-C-FO-17**



**EXTERIOR**

**INTERIOR**

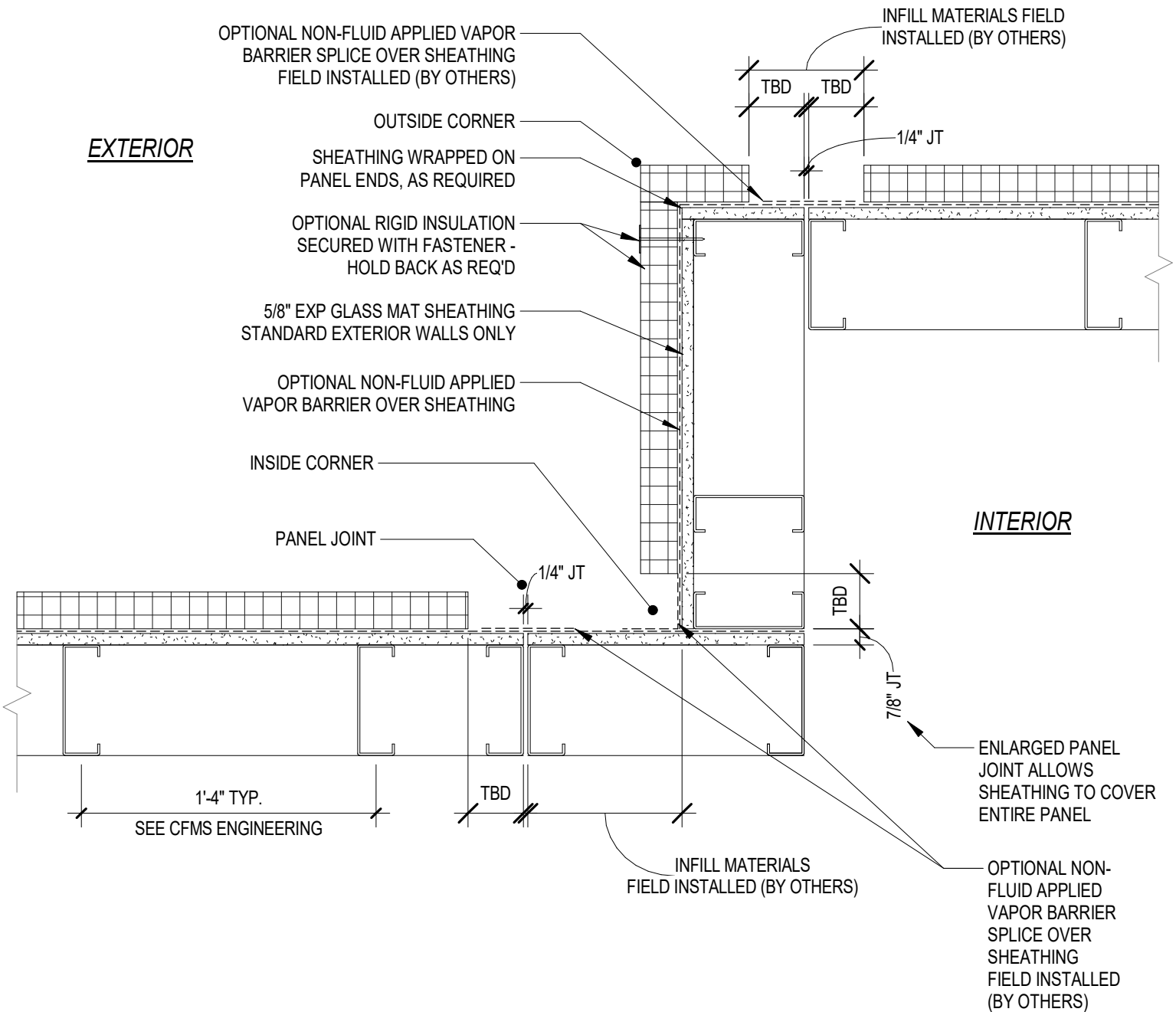

# PANEL JOINTS- EXTERIOR

1121 RICHLAND COMMERCE DRIVE; SUITE B  
QUAKERTOWN, PA 18951

Scale 1 1/2" = 1'-0"

Date: 06/29/21

**KWG-C-PJ-01**

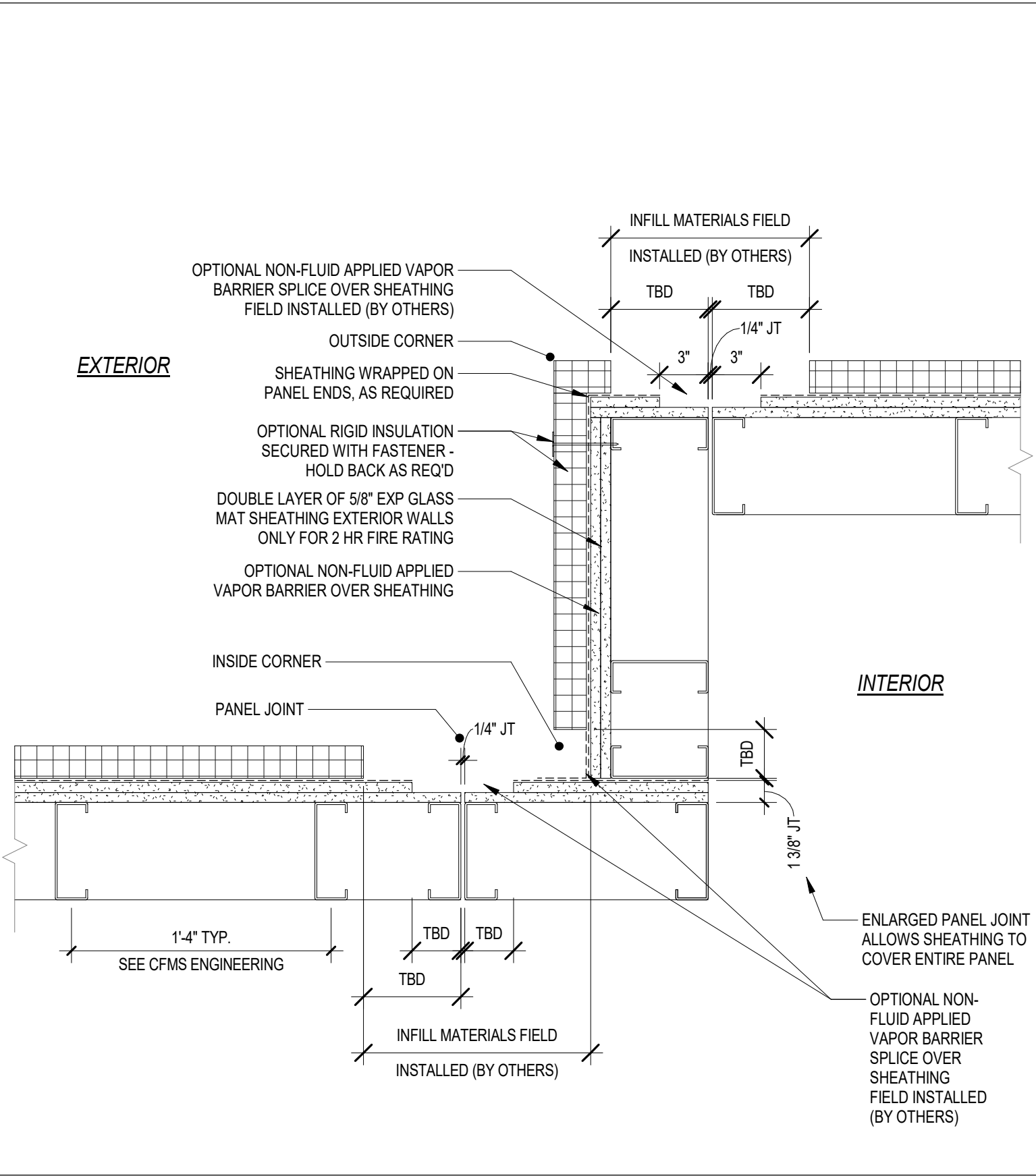

**PANEL JOINTS - EXTERIOR 2 HR.**

1121 RICHLAND COMMERCE DRIVE; SUITE B  
QUAKERTOWN, PA 18951

Scale 1 1/2" = 1'-0"  
Date: 06/29/21

**KWG-C-PJ-02**

INTERIOR

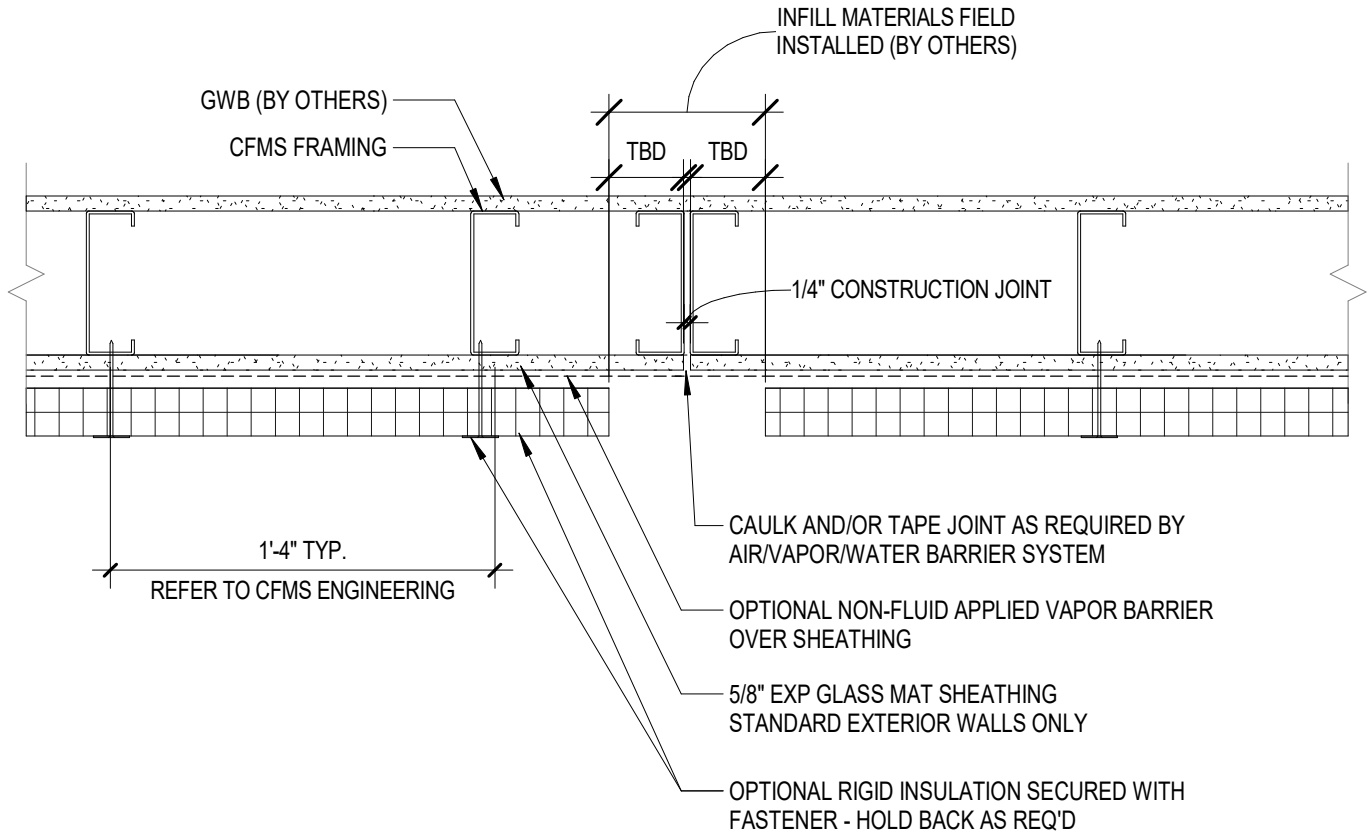

EXTERIOR



PANEL JOINT - VAPOR BARRIER  
FIELD TAPING OVER SHEATHING

1121 RICHLAND COMMERCE DRIVE; SUITE B  
QUAKERTOWN, PA 18951

Scale 1 1/2" = 1'-0"

Date: 06/29/21

KWG-C-PJ-03

INTERIOR

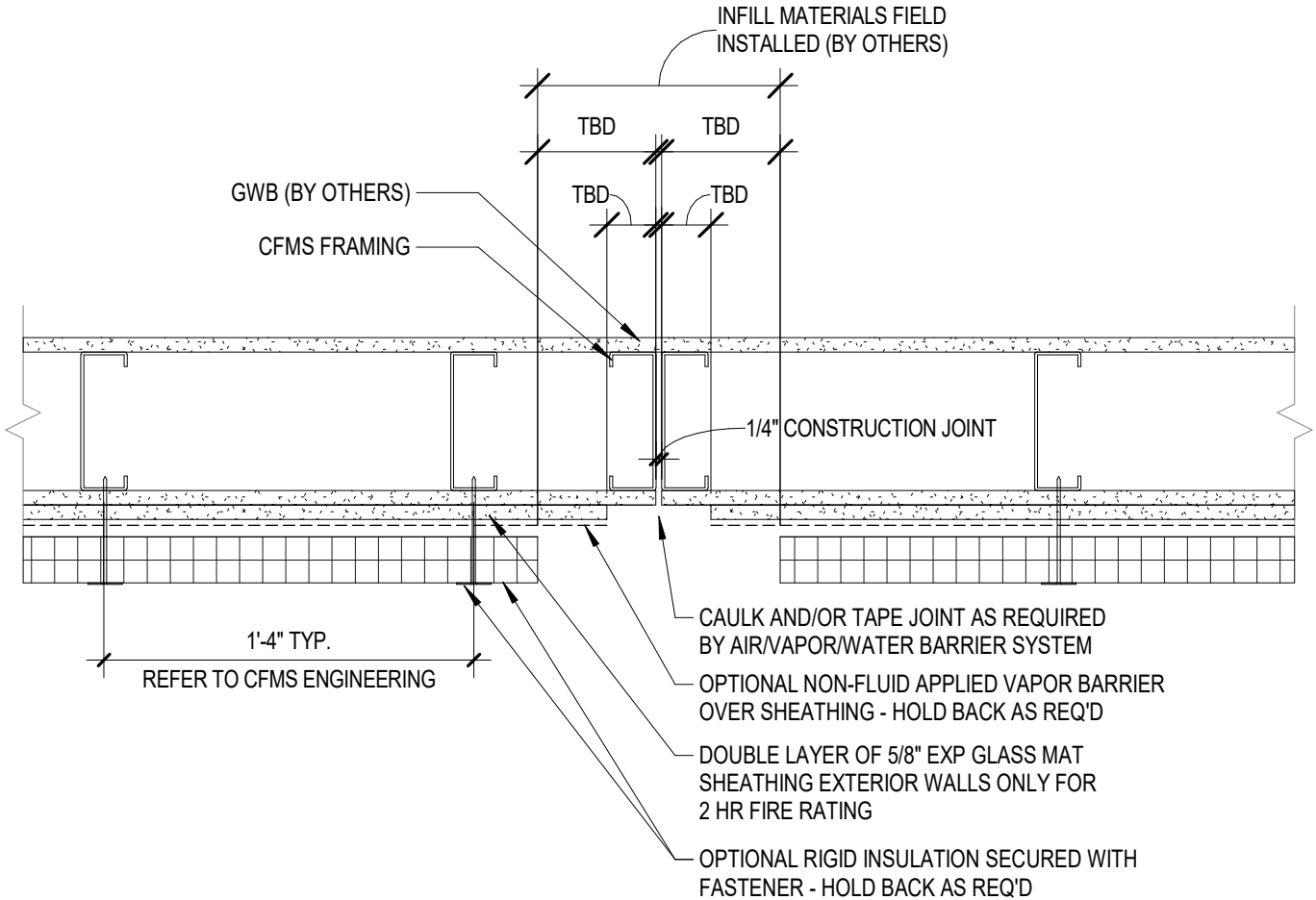

EXTERIOR



PNL JNT - VAPOR BARRIER FIELD TAPING OVER SHEATHING 2 HR.

1121 RICHLAND COMMERCE DRIVE; SUITE B  
QUAKERTOWN, PA 18951

Scale 1 1/2" = 1'-0"

Date: 06/29/21

KWG-C-PJ-04